



City of Sebastopol Planning Commission Staff Report

Meeting Date: December 13, 2022
Agenda Item: 6A
To: Planning Commission
From: John Jay, Associate Planner
Subject: Preliminary Review
Recommendation: None

Applicant/Owner: Kathy Austin/Pacific Realty Development
File Number: 2022-086
Address: 7621 Healdsburg Ave
CEQA Status: To be determined
General Plan: High Density Residential/Commercial Office
Zoning: Multi-Family Residential (R7)/Office Commercial (CO)

Introduction:

The applicant, Kathy Austin is looking for feedback from the Planning Commission on the proposed project at 7621 Healdsburg Avenue. This hearing is a preliminary review with the Planning Commission and no decision will be made. The project is a mixed-use development with commercial buildings on the frontage of Healdsburg Avenue and attached Townhomes on the southern end of the property that faces Murphy Avenue. The project will also include a Major Subdivision tentative map, Small lot subdivision, and Initial Study for environmental review. The project will also be heard by the Design Review Board at its regularly scheduled meeting on December 21, 2022.

Project Description:

The project proposes to construct fifteen 1120 SF 2-bedroom 2.5 bath 2-story town homes on the R7 zone and a 3,360sf +/- 2-story commercial bldg. with six 760 SF 1-bedroom 1 bath apartments above on the CO zone. The town homes have two suites to allowing for flexible living arrangements. To access the town homes, a proposed 20' private drive off Murphy Ave with a "T" turn around and a 20' wide private drive for 5 of the town homes. The trash and recycle center are also located near the end of the town home access road. Each town home has a 1 car garage and 1 tandem space in the driveway. A 20' driveway off Healdsburg Ave. is proposed, providing access to the rear 22 space parking lot for the mixed-use building. Half of the parking spaces are "tuck-under" the walkway above.

Project Location and Surrounding Land Uses:

The project is located along Healdsburg Ave on the northwestern end of the City. The surrounding land uses are Commercial Office and General Office along the Healdsburg Avenue Street. Behind the street frontage the use changes to Multi-Family residential including duplex and triplex units along Bately Court.

General Plan Consistency:

This project is consistent with the following General Plan policies as shown below.

- *Goal LU1 - Maintain Sebastopol as a unique, charming, and environmentally sensitive small town that provides residents, businesses, and visitors with opportunities to enjoy a high quality of life.*
- *Policy LU 1-2: Avoid urban sprawl by concentrating development within the City limits; favor infill development over annexation.*
- *Policy LU 5-5: Strongly encourage residential development in a balanced and efficient pattern that reduces sprawl, preserves open space, and creates convenient connections to other land uses.*
- *Policy LU 6-1: Promote increased residential densities.*
- *Policy LU 6-2: Promote compact urban form that provides residential opportunities in close proximity to jobs, services, and transit.*
- *Policy LU 7-1: Maintain an inventory of developable and appropriately zoned office, commercial, industrial, and mixed-use land sufficient to attract and provide regional services.*
- *Policy LU 7-6: Encourage mixed-use developments throughout the city.*
- *Policy LU 7-7: In mixed use, commercial, office, and other non-residential developments, encourage non-residential uses on the ground floor while allowing residential uses on the ground floor where appropriate.*
- *Housing Element Policy C-4: The City will encourage development of new housing to meet a range of income levels, including market-rate housing, and a variety of housing sizes and types.*
- *Housing Element Goal D-1: Promote Housing Affordability for both Renters and Homeowners*

Zoning Ordinance Consistency:

The project site has two zoning districts located within the property. The Office Commercial (CO) district fronts Healdsburg Avenue and the rear, southern part of the parcel with access to Murphy Avenue is zoned Multi-family Residential (R7). The project intends to develop the Commercially zoned part of the project with 3600 square feet of commercial space on the ground level, with six 760 square foot apartment units above. The second/southern half of the parcel that is zoned Multi-Family Residential (R7) and is subject to the R7 development standards as well as the small lot subdivisions standards set forth in Chapter 17.230 of the Sebastopol Municipal Code. The following development standards for the project are as follows:

Development Standard	Existing parcel	Existing parcel		Proposed	Proposed
Maximum building height	CO	R7		CO	R7
<i>Main buildings</i>	Currently vacant but would allow 32 ft, 2 stories	Currently vacant but would allow 30 ft., 2 stories		30 ft, 2 stories	30 ft, 2 stories
<i>Deed-restricted affordable housing, three stories</i>	Currently vacant but would allow 40 ft., 3 stories	Currently vacant but would allow 40 ft., 3 stories		NA	NA
	Minimum setbacks			Minimum setbacks	
<i>Front yard</i>	0 ft	10 ft.		5 ft	20 ft
<i>Interior side yard</i>	0 ft	10% of lot width, or 5 ft., whichever is greater, not to exceed 9 ft.(3)		10.8 ft on West property line, 13.4 ft on East property line	6 ft for Lot 15 to the Southern Property line, 0 ft between buildings
<i>Secondary front yard (corner lots)</i>	0 ft	10 ft.		NA	20 ft for Lot 1.
<i>Rear yard (main building)</i>	5 ft	20% of the lot depth, no less than 20 ft. nor greater than 25 ft.		176 ft	10 ft for Lots 3-10, 15.9 ft for Lots 11-15.
<i>Special setbacks – garage/carport opening facing the street</i>	NA	20 ft. from any exterior property line at the street		NA	20 ft for Lots 1-15
	Maximum floor area ratio	Maximum lot coverage		Maximum floor area ratio	Maximum lot coverage
	1.5	40%		15%	30%
Minimum residential density	50 sf/ DU	1 DU/3,600 sf lot area or 15.48 Units			1 DU/2645.33 or 21 units
Maximum residential density	1 DU/2900 sf lot area	1 DU/1,743 sf lot area or 31.97 Units		7.24 units	1 DU/2645.33 or 21 units

Required Findings:

As this report is only for the preliminary review of a project proposal, the required findings are not under review at this time. However, if this become a complete submission the project will be required to submit for a Major Subdivision (5 or more parcels), and would be subject to the State Subdivision Map Act and the findings in SMC Section 16.28.070 and 17.230.090 as follows:

A. In recommending approval or conditional approval or in approving or conditionally approving a tentative map, the Planning Commission or City Council as applicable shall find:

1. That the proposed subdivision, together with the provisions for its design and improvement, is consistent with the General Plan, any applicable specific plan, and other applicable provisions of this code; and
2. Except for condominium conversion projects where no new structures are added, that the design of the proposed subdivision provides, to the extent feasible, for future passive or natural heating or cooling opportunities in the subdivision, as described in the State Subdivision Map Act and any guidelines promulgated by the City Council.

B. In making recommendations or in disapproving, or in approving or in approving at a lower density a housing development which is in compliance with the applicable plans, zoning and development policies in effect at the time the project's application was determined to be complete, the Planning Commission or City Council, as applicable shall make written findings based upon substantial evidence in the record that both of the following conditions exist:

1. The housing development project would have a specific, adverse impact upon the public health or safety unless the project is disapproved or approved upon the condition that the project be developed at a lower density.
2. There is no feasible method to satisfactorily mitigate or avoid the adverse impact identified other than disapproval of the housing development project or approval upon condition that the project be developed at a lower density.

C. (not applicable to this development)

D. The Planning Commission may recommend, and the City Council may deny, approval of the tentative map on any grounds provided by law including, without limitation, a finding that the discharge of waste from the proposed subdivision into an existing community sewer system would result in, or add to, violation of existing requirements prescribed by a State regional water quality control board.

A tentative map shall be denied if any of the following findings are made:

1. That the proposed map is not consistent with the General Plan, applicable specific plans, or other applicable provisions of this code;
2. That the design or improvement of the proposed subdivision is not consistent with the General Plan, applicable specific plans, or other applicable provisions of this code;
3. That the site is not physically suitable for the type of development;

4. That the site is not physically suitable for the proposed density of development;
5. That the design of the subdivision or the proposed improvements are likely to cause substantial environmental damage or substantially and avoidably injure fish or wildlife or their habitat. Notwithstanding the foregoing, the City Council may approve such a tentative map if an environmental impact report was prepared with respect to the project and a finding was made pursuant to Section 21081 of CEQA that specific economic, social or other considerations make infeasible the mitigation measures or project alternatives identified in the environmental impact report;
6. That the design of the subdivision or the type of improvements are likely to cause serious public health problems;
7. That the design of the subdivision or the type of improvements will conflict with easements of record or easements established by court judgment, acquired by the public at large, for access through or use of property within the proposed subdivision. In this connection, the City Council may approve a map if they find that alternate easements for access or for use will be provided and that those will be substantially equivalent to ones previously acquired by the public. This subsection shall apply only to easements of record or to easements established by judgment of a court of competent jurisdiction, and no authority is hereby granted to the Planning Commission to determine that the public at large has acquired easements for access through or use of property within the proposed subdivision;
8. That all requirements of the California Environmental Quality Act and the rules and procedures adopted by the City Council pursuant thereto have not been met;
9. That the applicant has failed to submit complete or adequate information;
10. Subject to Section 66474.4 of the State Subdivision Map Act, that the land is subject to a contract entered into pursuant to the California Land Conservation Act of 1965 (commencing with Section 51200 of the Government Code) and that the resulting parcels following a subdivision of the land would be too small to sustain their agricultural use.

Section 17.230.090 - Findings for approval of small lot subdivisions.

Small lot subdivisions conforming to these provisions shall only be approved if the following findings can be made in an affirmative manner:

- A. The subject property is physically suitable for the type of development proposed;
- B. The proposed development would be compatible with existing and permissible land uses within the district and the general area in which the proposed use is to be located;
- C. The proposed development, including the density, site design, and design of units, is compatible with the existing neighborhood and nearby uses;

D. Approval of the proposed development will not be detrimental to the public health, safety, convenience, or general welfare; and

E. Approval of the proposed development is consistent with the General Plan.

Analysis:

The proposed project intends to increase the housing stock within the City of Sebastopol by developing a mixed-use development project that adds commercial businesses along the frontage of Healdsburg Ave where it is allowed with a building permit and includes attached townhomes on the rear of the property that is zoned for multi-family development. The commercial building along Healdsburg also includes residential living units or apartments above and is allowed as a part of the development standards in Chapter 17.25.030 of the SMC. The project would also achieve a list of General Plan goals as noted earlier in the staff report as well as helping Sebastopol reach its Regional Housing Needs Allocation goals for the next cycle.

While staff has not reviewed the proposal in detail for compliance with Subdivision ordinance provisions above, the main issues staff has identified are discussed below:

- Section 17.230.090, Criterion A, as the site will require grading work which will include large cuts into the hillside.

Site analysis

There are some constraints to the site itself as it is heavily wooded along with steep slopes. As the site moves away from Healdsburg Avenue it starts to climb up the hill towards Murphy Ave and with that would require an immense amount of grading work to be done. The applicant has provided a preliminary grading plan and grading numbers within the application.

Before this application was submitted, the applicant met with the City departments to go over the very early stages of the proposal and with that included a site plan which showed an internal connection through the site with ingress and egress onto Murphy and Healdsburg Avenue. After meeting with city staff, the applicant provided a modified submission as included in this staff report. Modifications were made to the site vehicle access as the applicant noted grading work to be done and retaining walls needed would be outside of the realm of possibility. The revised site plan is instead configured to have an entrance from Healdsburg to the mixed-use building (both the first-floor commercial uses and the second residential units) with parking behind this mixed-use structure. This site access no longer connects to the upper units/Murphy Avenue. The entrance from Murphy Avenue serves the townhomes on the southern portion of the site, it then dead ends on the eastern portion of the site where the trash enclosure will be located and where emergency vehicles would have to back up and turn around.

Staff would prefer if the driveway was able to connect from both Murphy Avenue and Healdsburg Ave/Hwy 116, as this provides additional flexibility to the residents and businesses, particularly during times Healdsburg Avenue is congested, as this portion of Healdsburg Avenue/Hwy 116 can experience vehicle delays during both rush hour and school drop off/pick up hours at Analy High School.

This traffic configuration will require both site and intersection-specific traffic analysis to ensure appropriate safety and queuing of vehicles. The Healdsburg/ Murphy intersection is also one of the intersections identified in the General Plan as needing to be upgraded to either a traffic

signal or potential round about. As this is a CalTrans right-of-way, a signal warrant will need to be included in the traffic study and, if warranted, work will need to be coordinated with CalTrans as Healdsburg Ave /Hwy 116 is a state right-of-way.

Lastly, as the site is heavily wooded with a variety of Oak trees and much of them would be slated for removal due to development impacts as noted in the arborist report. While it would be outside of the purview of the Planning Commission to provide requirements for tree removals, the Commission could recommend the applicant to revise the layout to preserve as many trees as possible.

Environmental Review:

The project does not fit within any of the categorical exemptions and would be subject to an environmental review. The level of environmental review for CEQA (California Environmental Quality Act) will be determined through an Initial Study at the time a formal application is submitted and deemed complete.

City Departmental Comments:

The Planning Department routed this project to all of the city departments and the following departments provided comments below:

- **Public Works:**
 - *The recommendations for utility location were made in the first meeting with this applicant, and will be reviewed once submitted.*
- **Building Department:**
 - *The Site access on page 36, which is the previous site plan, of the plan set shows a different traffic pattern than all the other sheets, and for traffic flow through the complex and onto Healdsburg Ave. The building department would prefer to see the driveway orientation connect through the site as shown on Page 36 of the plan set.*
- **Fire Department:**
 - *Standard fire department requirements will apply to this project.*
 - *Proper turn around radius for Emergency Access.*
- **City Arborist:**
 - *Report to be provided*

Public Comment:

As prescribed by Section 17.460 of the Zoning Ordinance, the Planning Department completed the following: (1) Provided written notice to all property owners within 600 feet of the external boundaries of the subject property.

No public comments have been received as of the writing of this staff report.

Recommendation:

No decision on the project will be made at this meeting. However, the applicant is requesting feedback from the Planning Commission on the scope of the project. In particular, staff requests the Planning Commission discuss the following areas and provide feedback to the applicant and staff:

- Overall mix of uses and proposed site layout and proposed subdivision of land
- Driveway access and connectivity within the site

- Possibility of residential on first floor that could provide more ADA units within the development

Attachments:

Application Materials



City of Sebastopol
Planning Department
APPLICATION ROUTING FORM

To: [X] Kari Svanstrom, Planning Director
[X] Becky Duckles, City Arborist
[X] Bill Braga, Fire Chief
[X] Dante Del Prete, Public Works Superintendent
[X] Steve Brown, Senior Building Inspector
[X] Police Department
[X] Mario Landeros, GHD, Interim City Engineer
[X] Larry McLaughlin, City Manager / City Attorney
[X] Mary Gourley, Assistant City Manager / City Clerk
[] Sonoma County Health, Environmental Health Division (via email)
[] Graton Racheria, Tribal Heritage Preservation Officer (via email)
[] Laguna Foundation (via email)

From: *Elise Blindauer, Planning Technician*

Date: *November 30, 2022*

Subject: *Preliminary Design Review & Planning Commission Review – 7621 Healdsburg Avenue – Project # 2022-086 – Mixed-use Development*

The applicant is proposing to build fifteen 2-story town homes on the R7 zone and a 3,360 square foot +/- 2-story commercial building on the CO zone. The town homes are planned to be 1120 square foot with 2-bedrooms and 2.5 baths. The commercial building is proposed to have six 760 square foot, 1-bedroom, 1 bath apartments above the commercial space. Both the town homes and the mixed-use building will have their own separate 20-foot driveways.

Please provide any comments and/or conditions by **Monday, December 12th, 2022.**



City of Sebastopol

Planning Department
7120 Bodega Avenue
Sebastopol, CA 95472
(707) 823-6167

**MASTER PLANNING
APPLICATION FORM**

APPLICATION TYPE

- | | | |
|--|---|---|
| <input type="checkbox"/> Administrative Permit Review | <input type="checkbox"/> Lot Line Adjustment/Merger | <input type="checkbox"/> Temporary Use Permit |
| <input type="checkbox"/> Alcohol Use Permit/ABC Transfer | <input type="checkbox"/> Preapplication Conference | <input type="checkbox"/> Tree Removal Permit |
| <input type="checkbox"/> Conditional Use Permit | <input type="checkbox"/> Preliminary Review | <input type="checkbox"/> Variance |
| <input type="checkbox"/> Design Review | <input type="checkbox"/> Sign Permit | <input type="checkbox"/> Other _____ |

This application includes the checklist(s) or supplement form(s) for the type of permit requested: Yes No

REVIEW/HEARING BODIES

- Staff/Admin Design Review/Tree Board Planning Commission City Council Other _____

APPLICATION FOR

Street Address: _____ Assessor's Parcel No(s): _____

Present Use of Property: _____ Zoning/General Plan Designation: _____

APPLICANT INFORMATION

Property Owner Name: _____

Mailing Address: _____ Phone: _____

City/State/ZIP: _____ Email: _____

Signature: _____ Date: _____

Authorized Agent/Applicant Name: _____

Mailing Address: _____ Phone: _____

City/State/ZIP: _____ Email: _____

Signature: _____ Date: _____

Contact Name (If different from above): _____ Phone/Email: _____

PROJECT DESCRIPTION AND PERMITS REQUESTED (ATTACH ADDITIONAL PAGES IF NECESSARY)

CITY USE ONLY

Fill out upon receipt:		Action:	Action Date:
Application Date:	_____	Staff/Admin:	Date: _____
Planning File #:	_____	Planning Director:	Date: _____
Received By:	_____	Design Review/Tree Board:	Date: _____
Fee(s):	\$ _____	Planning Commission:	Date: _____
Completeness Date:	_____	City Council:	Date: _____

SITE DATA TABLE

If an item is not applicable to your project, please indicate "Not Applicable" or "N/A" in the appropriate box; do not leave cells blank.

SITE DATA TABLE	REQUIRED / ZONING STANDARD	EXISTING	PROPOSED
Zoning	N/A		
Use	N/A		
Lot Size			
Square Feet of Building/Structures <i>(if multiple structures include all separately)</i>			
Floor Area Ratio (F.A.R)	_____ FAR	_____ FAR	_____ FAR
Lot Coverage	_____ % of lot	_____ % of lot	_____ % of lot
	_____ sq. ft.	_____ sq. ft.	_____ sq. ft.
Parking			
Building Height			
Number of Stories			
Building Setbacks – Primary			
<i>Front</i>			
<i>Secondary Front Yard (corner lots)</i>			
<i>Side – Interior</i>			
<i>Rear</i>			
Building Setbacks – Accessory			
<i>Front</i>			
<i>Secondary Front Yard (corner lots)</i>			
<i>Side – Interior</i>			
<i>Rear</i>			
Special Setbacks (if applicable)			
<i>Other (_____)</i>			
Number of Residential Units	_____ Dwelling Unit(s)	_____ Dwelling Unit(s)	_____ Dwelling Unit(s)
Residential Density	1 unit per _____ sq. ft.	1 unit per _____ sq. ft.	1 unit per _____ sq. ft.
Useable Open Space	_____ sq. ft.	_____ sq. ft.	_____ sq. ft.
Grading	Grading should be minimized to the extent feasible to reflect existing topography and protect significant site features, including trees.	N/A	Total: _____ cu. yds. Cut: _____ cu. yds. Fill: _____ cu. yds. Off-Haul: _____ cu. yds
Impervious Surface Area	N/A	_____ % of lot	_____ % of lot
		_____ sq. ft.	_____ sq. ft.
Pervious Surface Area	N/A	_____ % of lot	_____ % of lot
		_____ sq. ft.	_____ sq. ft.

CONDITIONS OF APPLICATION

1. All Materials submitted in conjunction with this form shall be considered a part of this application.
2. This application will not be considered filed and processing may not be initiated until the Planning Department determines that the submittal is complete with all necessary information and is "accepted as complete." The City will notify the applicant of all application deficiencies no later than 30 days following application submittal.
3. The property owner authorizes the listed authorized agent(s)/contact(s) to appear before the City Council, Planning Commission, Design Review/Tree Board and Planning Director and to file applications, plans, and other information on the owner's behalf.
4. The Owner shall inform the Planning Department in writing of any changes.
5. **INDEMNIFICATION AGREEMENT:** As part of this application, applicant agrees to defend, indemnify, release and hold harmless the City, its agents, officers, attorneys, employees, boards, committees and commissions from any claim, action or proceeding brought against any of the foregoing individuals or entities, the purpose of which is to attack, set aside, void or annul the approval of this application or the adoption of the environmental document which accompanies it or otherwise arises out of or in connection with the City's action on this application. This indemnification shall include, but not be limited to, damages, costs, expenses, attorney fees or expert witness fees that may be asserted by any person or entity, including the applicant, arising out of or in connection with the City's action on this application, whether or not there is concurrent passive or active negligence on the part of the City.

If, for any reason, any portion of this indemnification agreement is held to be void or unenforceable by a court of competent jurisdiction, the remainder of the agreement shall remain in full force and effect.

NOTE: The purpose of the indemnification agreement is to allow the City to be held harmless in terms of potential legal costs and liabilities in conjunction with permit processing and approval.

6. **REPRODUCTION AND CIRCULATION OF PLANS:** I hereby authorize the Planning Department to reproduce plans and exhibits as necessary for the processing of this application. I understand that this may include circulating copies of the reduced plans for public inspection. Multiple signatures are required when plans are prepared by multiple professionals.
7. **NOTICE OF MAILING:** Email addresses will be used for sending out staff reports and agendas to applicants, their representatives, property owners, and others to be notified.
8. **DEPOSIT ACCOUNT INFORMATION:** Rather than flat fees, some applications require a 'Deposit'. The initial deposit amount is based on typical processing costs. However, each application is different and will experience different costs. The City staff and City consultant time, in addition to other permit processing costs, (i.e., legal advertisements and copying costs are charged against the application deposit). If charges exceed the initial deposit, the applicant will receive billing from the City's Finance department. If at the end of the application process, charges are less than the deposit, the City Finance department will refund the remaining monies. Deposit accounts will be held open for up to 90 days after action or withdrawal for the City to complete any miscellaneous clean up items and to account for all project related costs.
9. **NOTICE OF ORDINANCE/PLAN MODIFICATIONS:** Pursuant to Government Code Section 65945(a), please indicate, by checking the boxes below, if you would like to receive a notice from the City of any proposal to adopt or amend any of the following plans or ordinances if the City determines that the proposal is reasonably related to your request for a development permit:

<input checked="" type="checkbox"/> A general plan	<input checked="" type="checkbox"/> A specific plan
<input checked="" type="checkbox"/> An ordinance affecting building permits or grading permits	<input checked="" type="checkbox"/> A zoning ordinance

Certification

I, the undersigned owner of the subject property, have read this application for a development permit and agree with all of the above and certify that the information, drawings and specifications herewith submitted are true and correct to the best of my knowledge and belief and are submitted under penalty of perjury. I hereby grant members of the Planning Commission, Design Review Board and City Staff admittance to the subject property as necessary for processing of the project application.

Property Owner's Signature: [Signature] Date: 4/18/22
10/4/22

I, the undersigned applicant, have read this application for a development permit and agree with all of the above and certify that the information, drawings and specifications herewith submitted are true and correct to the best of my knowledge and belief and are submitted under penalty of perjury.

Applicant's Signature: [Signature] Date: 4.19.2022 10-4-2022
Updated Application

NOTE: It is the responsibility of the applicant and their representatives to be aware of and abide by City laws and policies. City staff, Boards, Commissions, and the City Council will review applications as required by law; however, the applicant has responsibility for determining and following applicable regulations.

Neighbor Notification

In the interest of being a good neighbor, it is highly recommended that you contact those homes or businesses directly adjacent to, or within the area of your project. Please inform them of the proposed project, including construction activity and possible impacts such as noise, traffic interruptions, dust, larger structures, tree removals, etc.

Many projects in Sebastopol are remodel projects which when initiated bring concern to neighboring property owners, residents, and businesses. Construction activities can be disruptive, and additions or new buildings can affect privacy, sunlight, or landscaping. Some of these concerns can be alleviated by neighbor-to-neighbor contacts early in the design and construction process.

It is a “good neighbor policy” to inform your neighbors so that they understand your project. This will enable you to begin your construction with the understanding of your neighbors and will help promote good neighborhood relationships.

Many times, development projects can have an adverse effect on the tranquility of neighborhoods and tarnish relationships along the way. If you should have questions about who to contact or need property owner information in your immediate vicinity, please contact the Building and Safety Department for information at (707) 823-8597, or the Planning Department at (707) 823-6167.

I have informed site neighbors of my proposed project: Yes No

If yes, or if you will inform neighbors in the future, please describe outreach efforts:

Website Required for Major Projects

Applicants for major development projects (which involves proposed development of **10,000 square feet of new floor area or greater, or 15 or more dwelling units/lots**), are required to create a project website in conjunction with submittal of an application for Planning approval (including but not limited to Subdivisions, Use Permits, Rezoning, and Design Review). Required information may be provided on an existing applicant web site.

The website address shall be provided as part of the application. The website shall be maintained and updated, as needed until final discretionary approvals are obtained for the project.

Such website shall include, at a minimum, the following information:

- ✓ Project description
- ✓ Contact information for the applicant, including address, phone number, and email address
- ✓ Map showing project location
- ✓ Photographs of project site
- ✓ Project plans and drawings

October 10, 2022

To: Design Review Board, Planning Commission and Staff, City of Sebastopol
Re: Preliminary Review of a Mixed-Use Development, 7621 Healdsburg Ave.
From: Katherine Austin, AIA Project Architect

Proposed Project Description:

The intent of our proposal is to provide much needed housing for Sebastopol in smaller town homes as well as an attractive contemporary frontage development of commercial spaces with apartments above on Healdsburg Avenue. We are attempting to save as many mature oak trees on the site as possible while still providing the needed circulation and parking required per city standards. Grading was carefully considered to save most trees on the south and east areas between the town homes and property lines. The homes floor levels were adjusted to meet grade in the rear while change in grade in front is adjusted in the garage levels. Most homes have garages that are level with the 1st floor. Foundations will be designed with roots in mind.

Our design consists of fifteen 1120 SF 2-bedroom 2.5 bath 2-story town homes on the R7 zone and a 3,360sf +/- 2-story commercial bldg. with six 760 SF 1-bedroom 1 bath apartments above on the CO zone. The town homes have two suites to allowing for flexible living arrangements.

To access the town homes, we propose a 20' private drive off Murphy Ave with a "T" turn around and a 20' wide private drive for 5 of the town homes. The roadway is 26' wide at the end next to the fire hydrant per the Fire Dept. The trash and recycle center are also located near the end of the town home access road. Each town home has a 1 car garage and 1 tandem space in the driveway. We propose to make those driveways of permeable concrete. Between driveways we propose planting two small trees to help with the storm water mitigation which is provided around the site in many retention areas as indicated in the Civil Engineering plans.

A 20' driveway off Healdsburg Ave. is proposed, providing access to the rear 22 space parking lot for the mixed-use building. Half of the parking spaces are "tuck-under" the walkway above. On the south side of the parking lot is a stepped retaining wall that will contain storm water filtration and include plantings. A railing will be placed at the top of the wall to prevent falling. A cross walk from the town homes leading to the north stairs will continue a path to Healdsburg Ave. The accessible route of travel is by public sidewalk along Murphy Ave to Healdsburg Ave. Overflow visitor parking can be provided in the parking lot with access by stair to the homes.

A handicap parking space is provided next to the elevator that serves the upper apartments which each have a semiprivate outdoor area in front. One unit will be built out for accessibility and the remainder will be adaptable. Each have their own laundry and there is a skylight letting light into the center of the units. A canted bay window on the north is intended to block the hottest setting sun of the summer and is a passive cooling feature.

All town homes have a small flat portion of roof that will contain the compressors, tankless hot water heaters and solar PV array out of sight. The mixed-use building also has a low-pitched roof with solar PV, compressors, and tankless water heaters all out of sight. All storm water from roofs is conducted to retention areas that are landscaped. Natural stain cedar is used throughout the development along with a simple color scheme of light and dark grey which will harmonize with the development colors to the west.

After review we will continue design to include EV charging stations, dark sky lighting, bike parking and other items which we will bring forward in our formal submittal.



- Conceptual Plan includes:
1. Retention of existing oaks along the south and east PL
 2. Street Trees 20' OC along Healdsburg Ave. Crepe Myrtles or other per city requirements
 3. Tall evergreens at retention area at upper Trash/Recycle bin
 4. Two paired small trees in front of Town Homes in retention areas Crepe Myrtles and Maple or Ornamental purple plums.
 5. Larger specimen trees in retention areas to west and south per City specimen requirements
 6. Ornamental grasses and ground cover in catchment areas

1 Existing Oaks to be retained

1 Existing Oaks to be retained

Existing Oaks to be retained

Conceptual Landscape Plan

REVISIONS	BY

7621 Healdsburg Ave., Sebastopol, CA 95472
Town Home and Mixed Use Development

Katherine Austin, AIA, Architect
524 South Main St., Sebastopol, CA 95472
179 SE Rice Way, Bend, OR 97702
707-529-5565 kaaustin@pacbell.net

Date	9-30-2022
Scale	1"=20'
Drawn	K. Austin
Job	
Sheet	1
Of	6
	Sheets

REVISIONS	BY

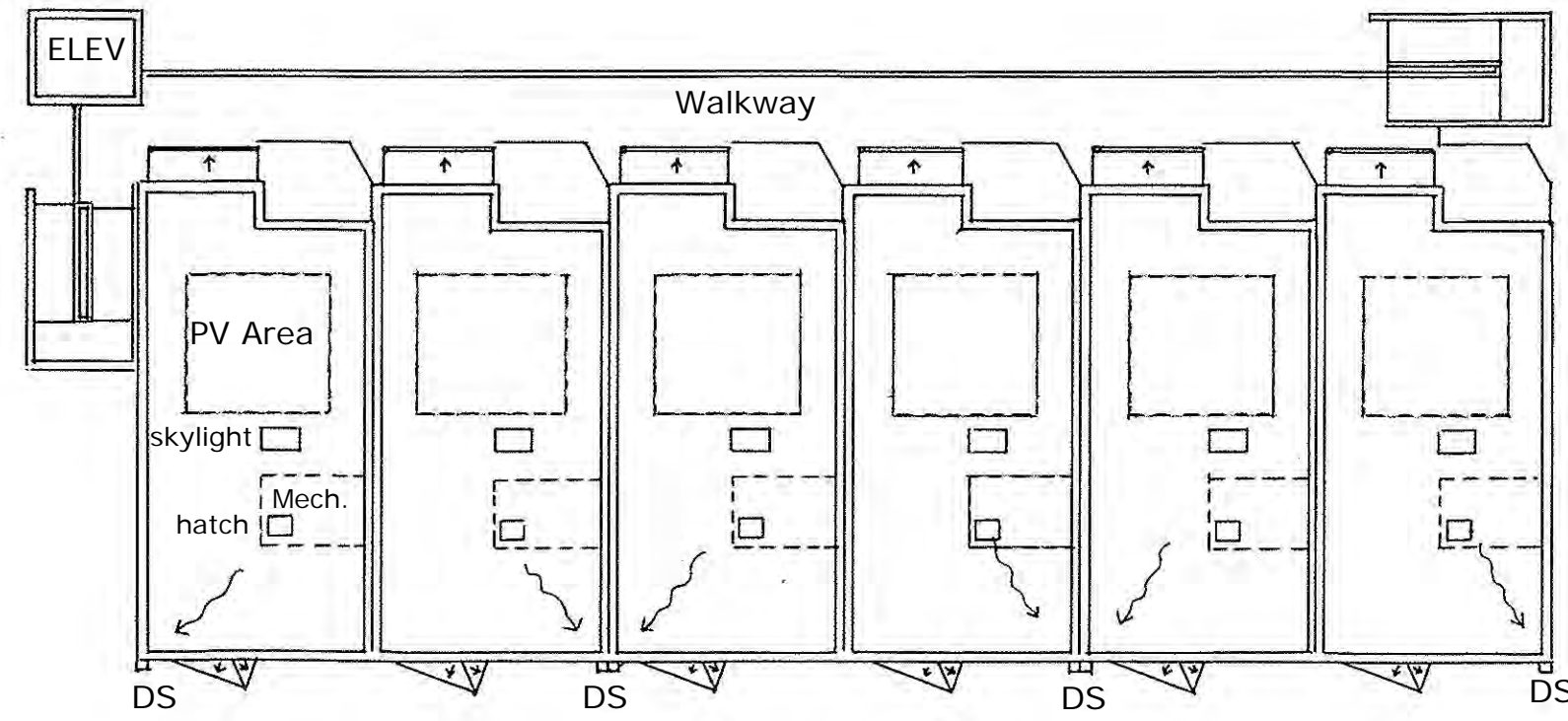

Roof Plan
1/16" = 1'-0"



Six 760 SF One Bedroom One Bath Apartments

Second Floor Plan
1/16" = 1'-0"

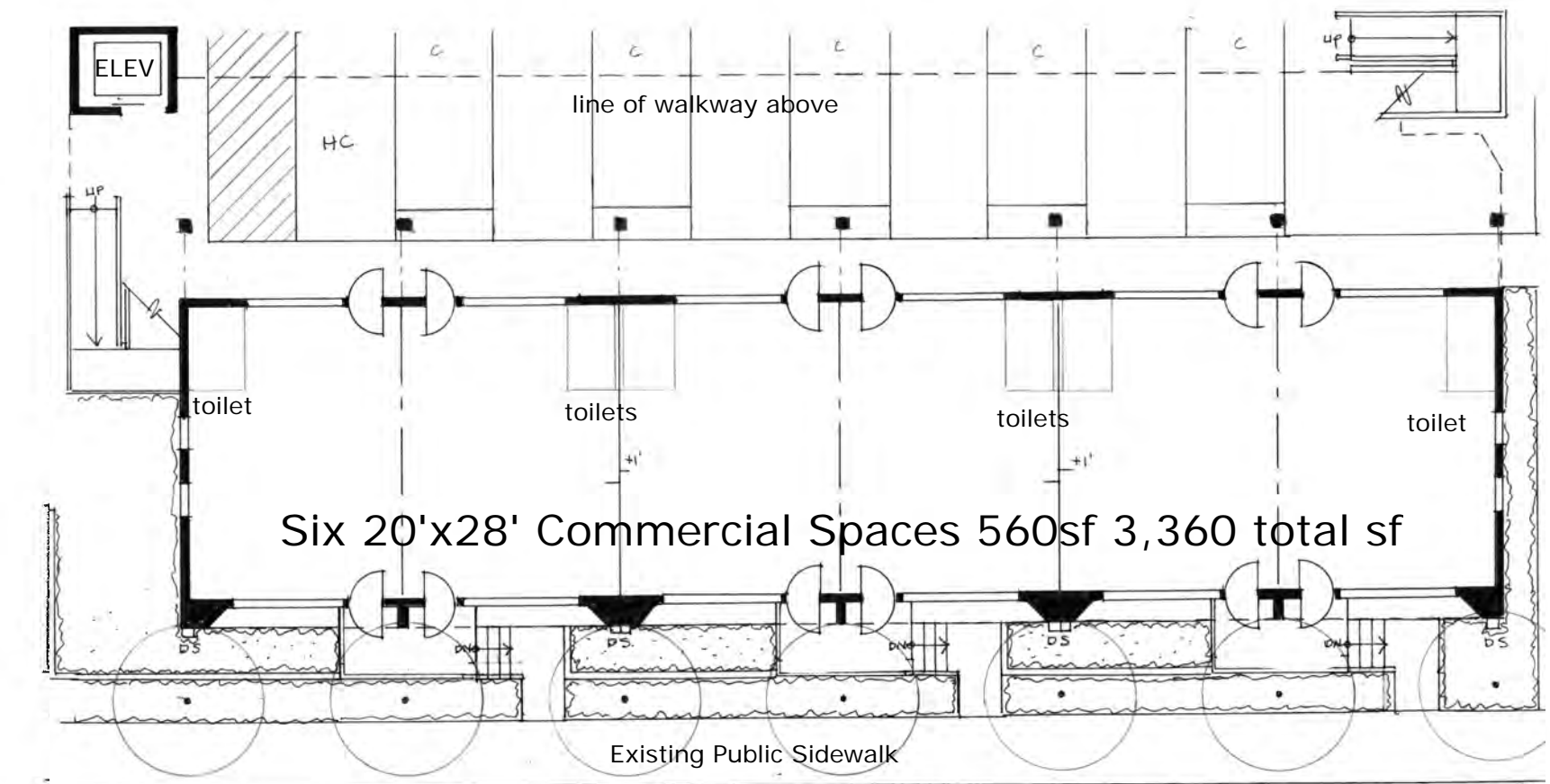

First Floor Plan
1/16" = 1'-0"

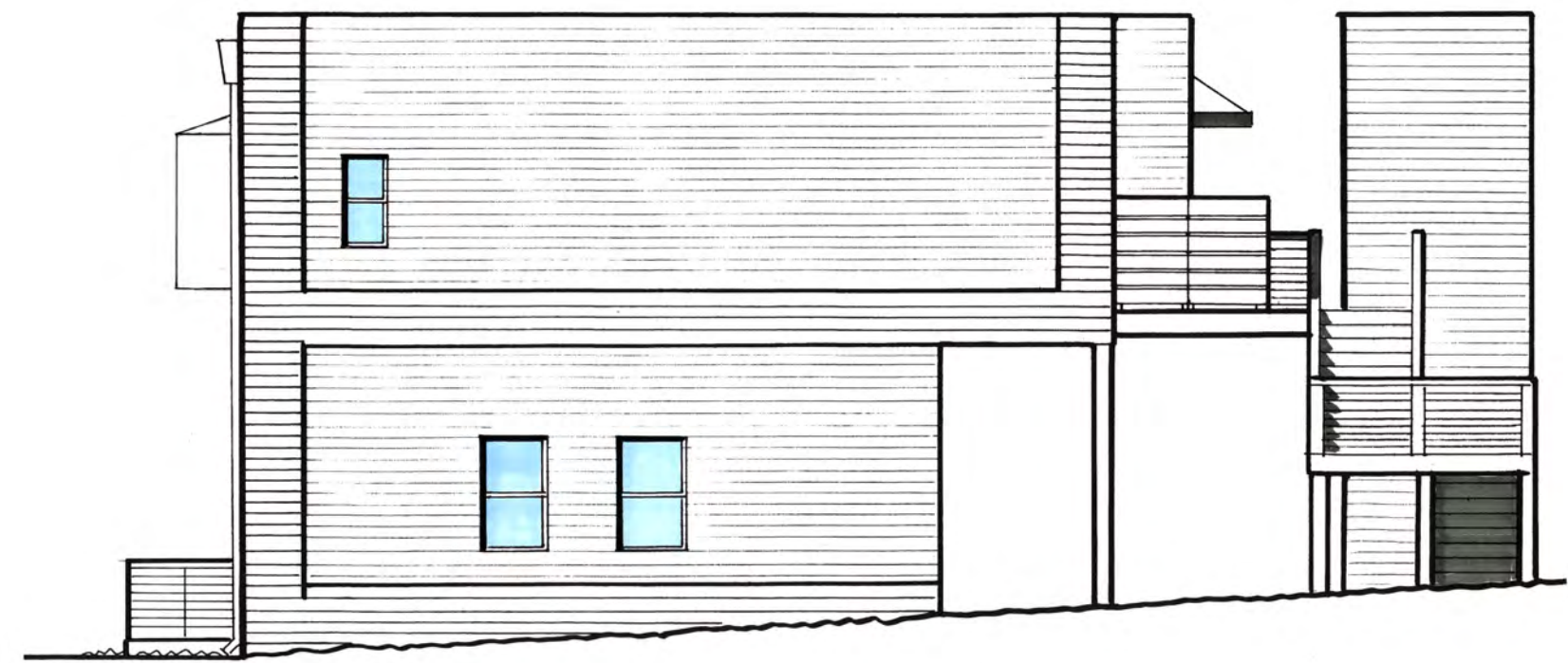

West Elevation
1/8" = 1'-0"



North Elevation
1/8" = 1'-0"



East Elevation
1/8" = 1'-0"



South Elevation on Healdsburg Ave.
1/8" = 1'-0"

7621 Healdsburg Ave., Sebastopol, CA 95472
Town Home and Mixed Use Development

Katherine Austin, AIA, Architect
524 South Main St., Sebastopol, CA 95472
179 SE Rice Way, Bend, OR 97702
707-529-5565 kaaustin@pacbell.net

Date	9-27-2022
Scale	as noted
Drawn	K. Austin
Job	
Sheet	2
Of	6



West Elevation Rendering



East Elevation Rendering



South Elevation Rendering



North Elevation Rendering View on Healdsburg Avenue

REVISIONS	BY

7621 Healdsburg Ave., Sebastopol, CA 95472
 Town Home and Mixed Use Development

Katherine Austin, AIA, Architect
 524 South Main St., Sebastopol, CA 95472
 179 SE Rice Way, Bend, OR 97702
 707-529-5565

Date 9-27-2022

Scale 1/8" = 1'0"

Drawn K. Austin

Job

Sheet

3 6

Or Sheets

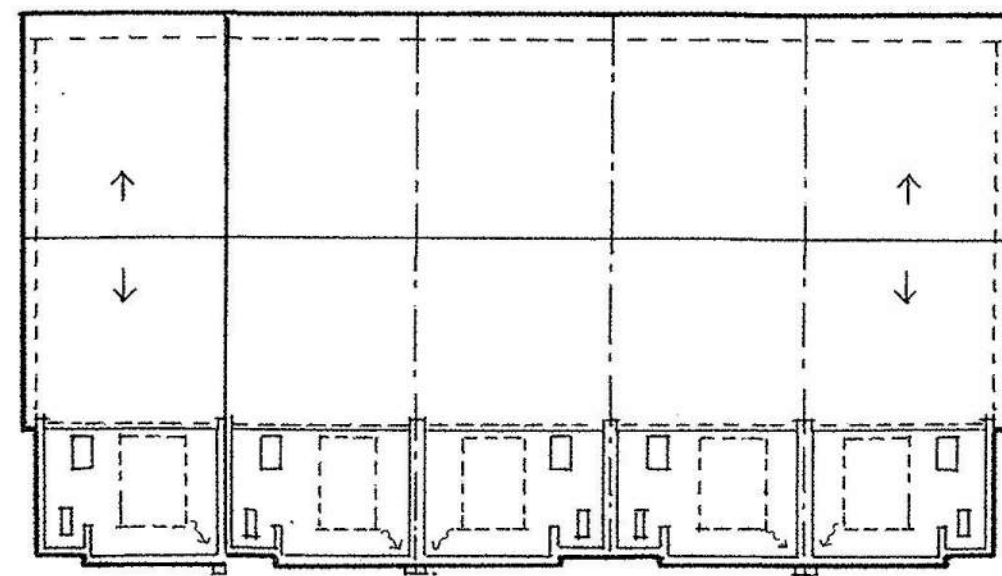

Roof Plans

81'-4" side wall to side wall

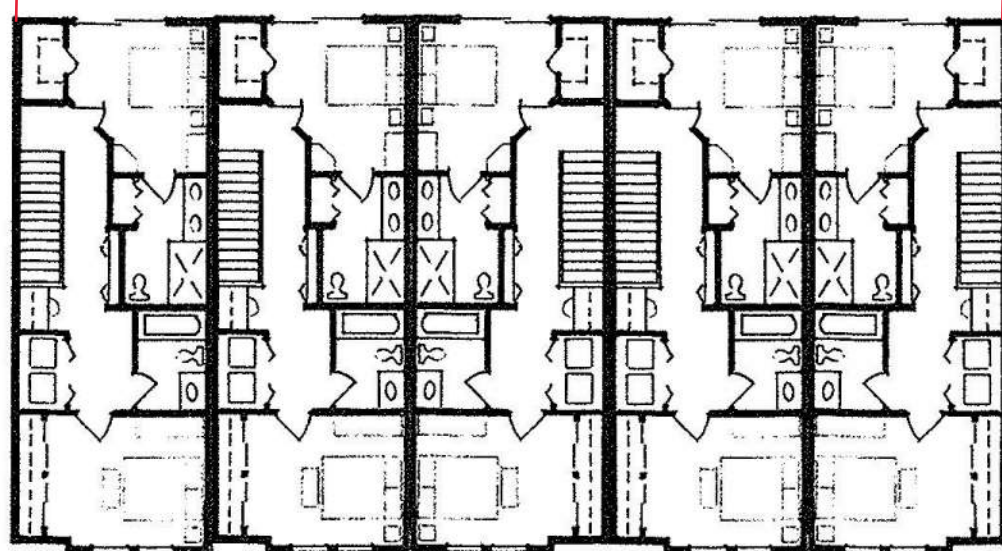

Second Floor Plans

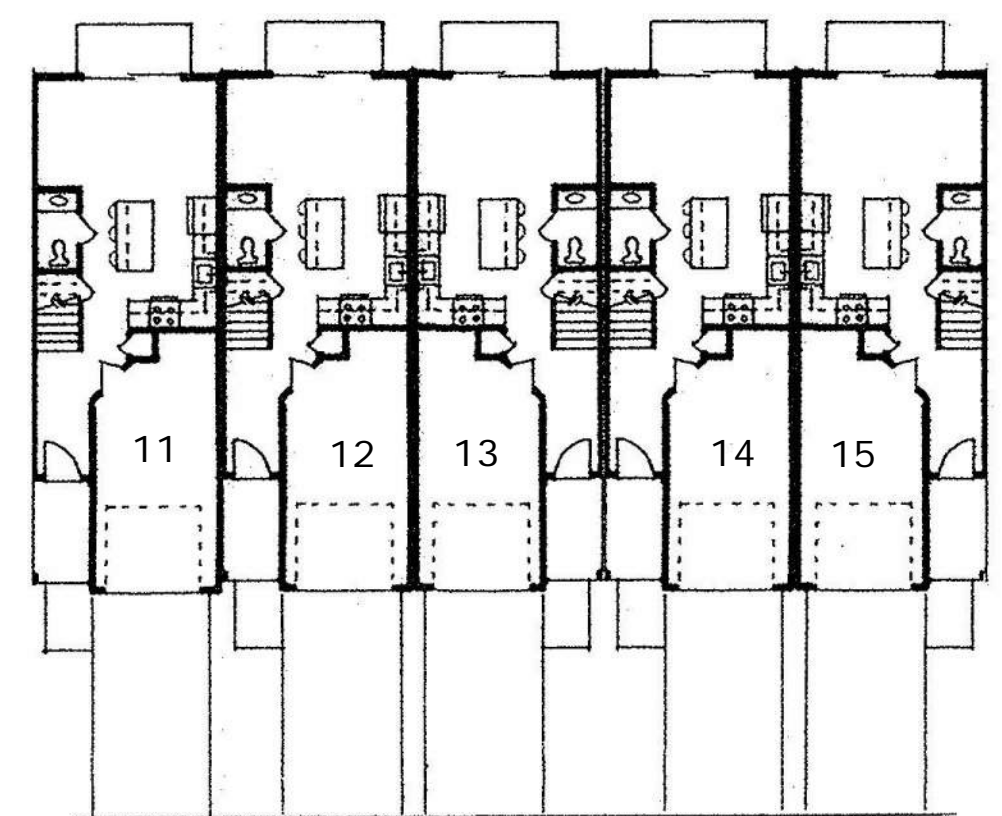

Town Homes 11 - 15 First Floor Plans 1/16"=1'-0"

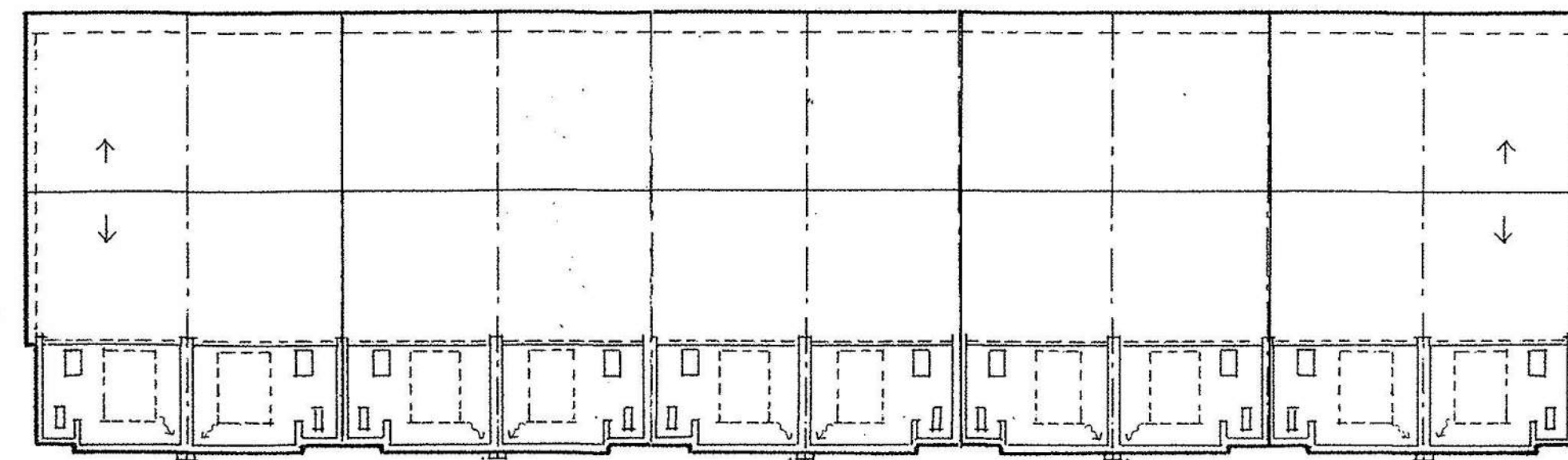

Roof Plans

163" side wall to side wall

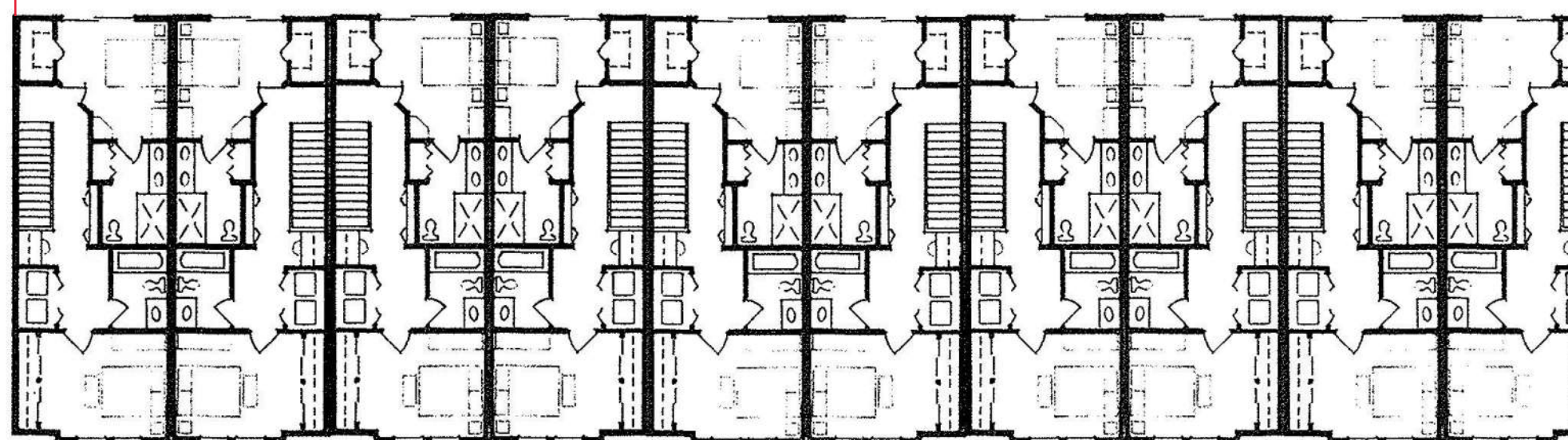

Second Floor Plans

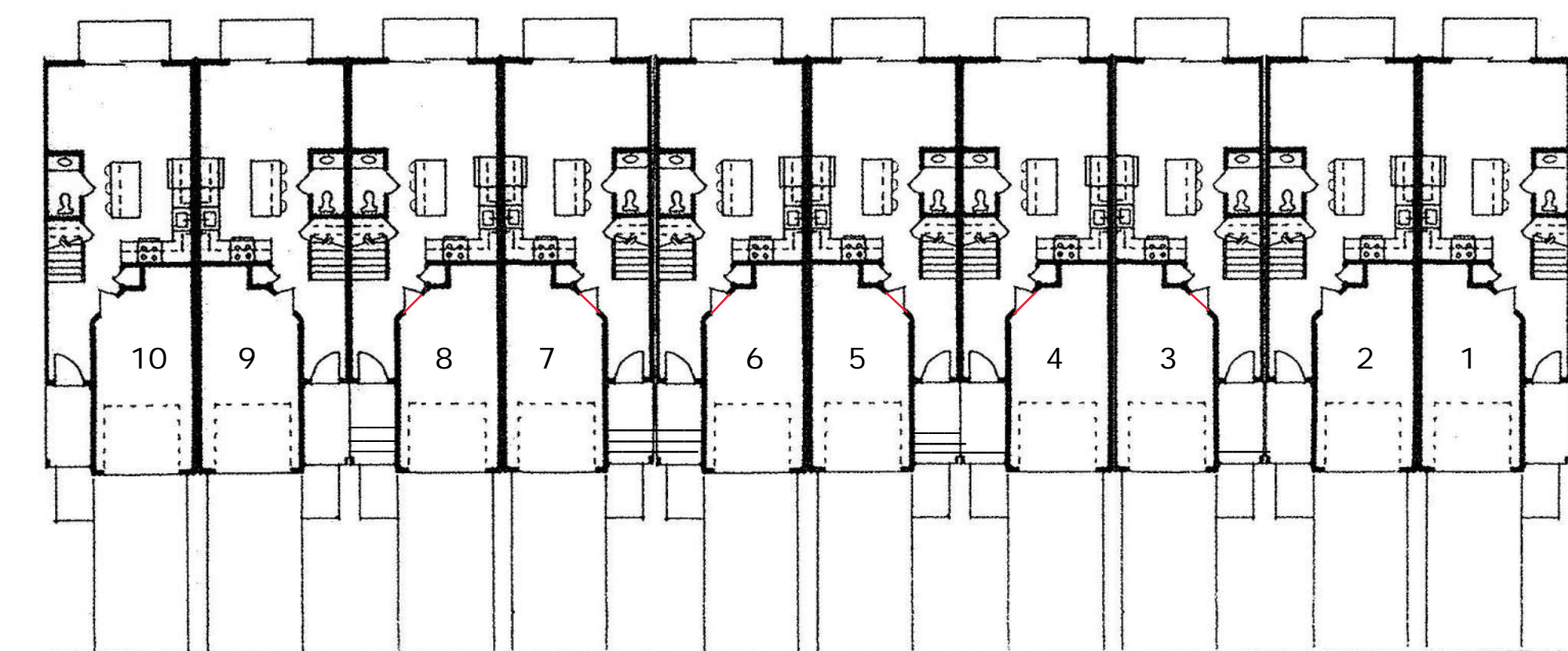

Town Homes 1 - 10 First Floor Plans 1/16"=1'-0"

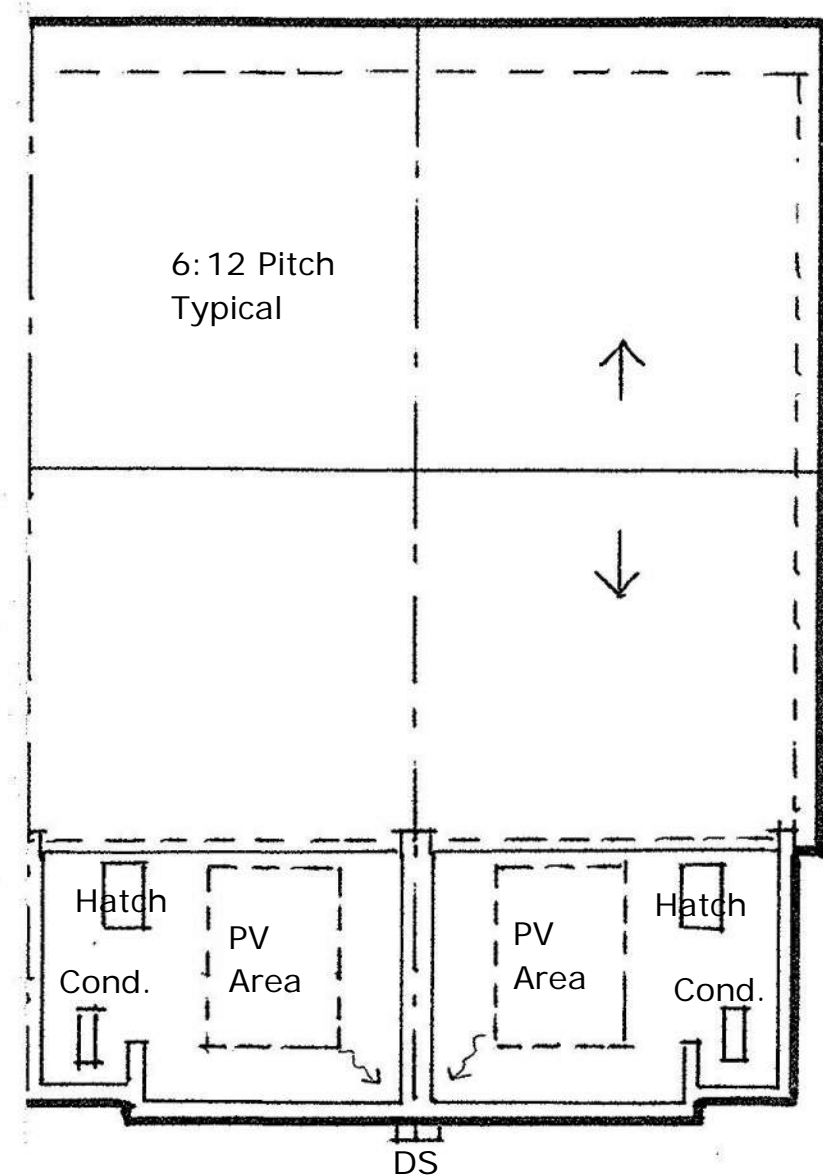

Plans at 1/8"=1'-0"

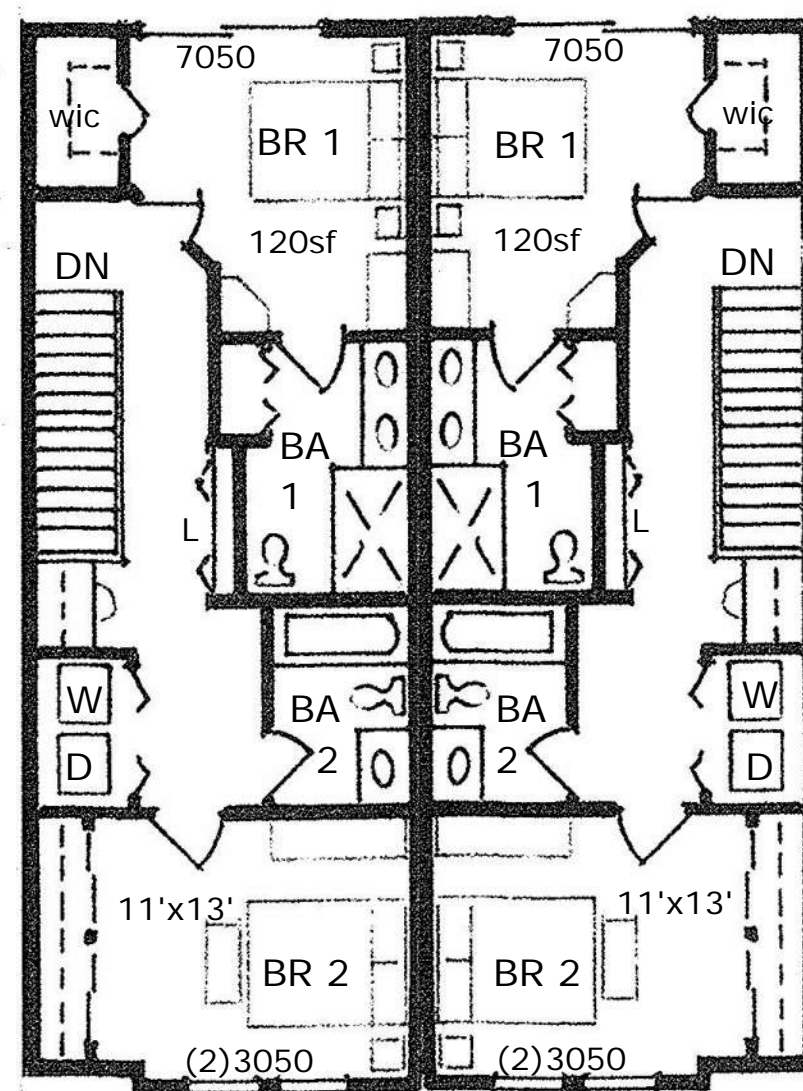

1120 SF 2 Story Town Homes
2Br, 2.5Ba, 1-Car Garage

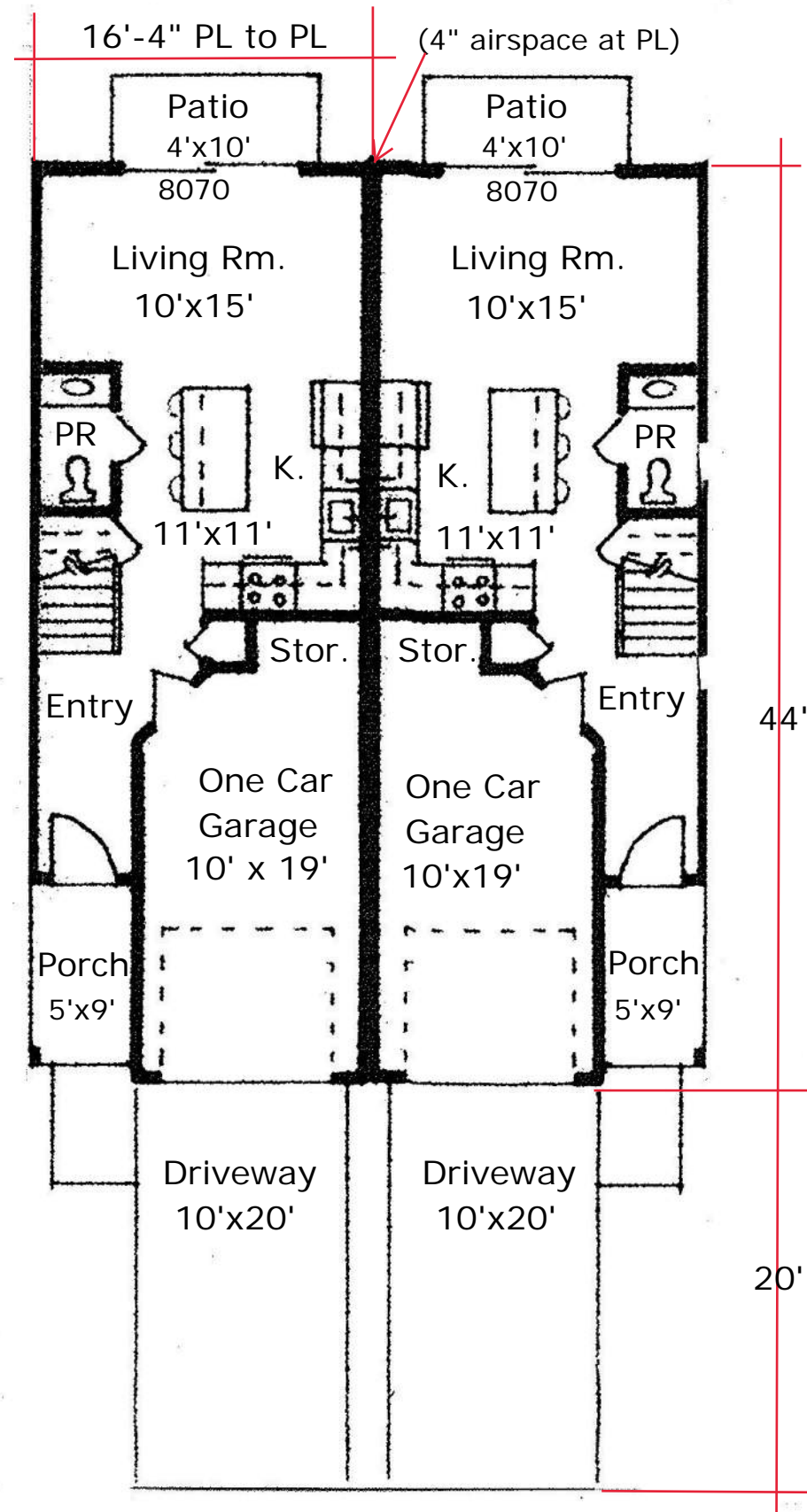

REVISIONS	BY

7621 Healdsburg Ave., Sebastopol, CA 95472
Town Home and Mixed Use Development

Katherine Austin, AIA, Architect
524 South Main St., Sebastopol, CA 95472
179 SE Rice Way, Bend, OR 97702
707-529-5565 kaustin@pacbell.net

Date	9-23-2022
Scale	as noted
Drawn	K. Austin
Job	
Sheet	6
Of	4



Rear Elevations of Town Homes 1 through 10



Right Side of Town Home 1

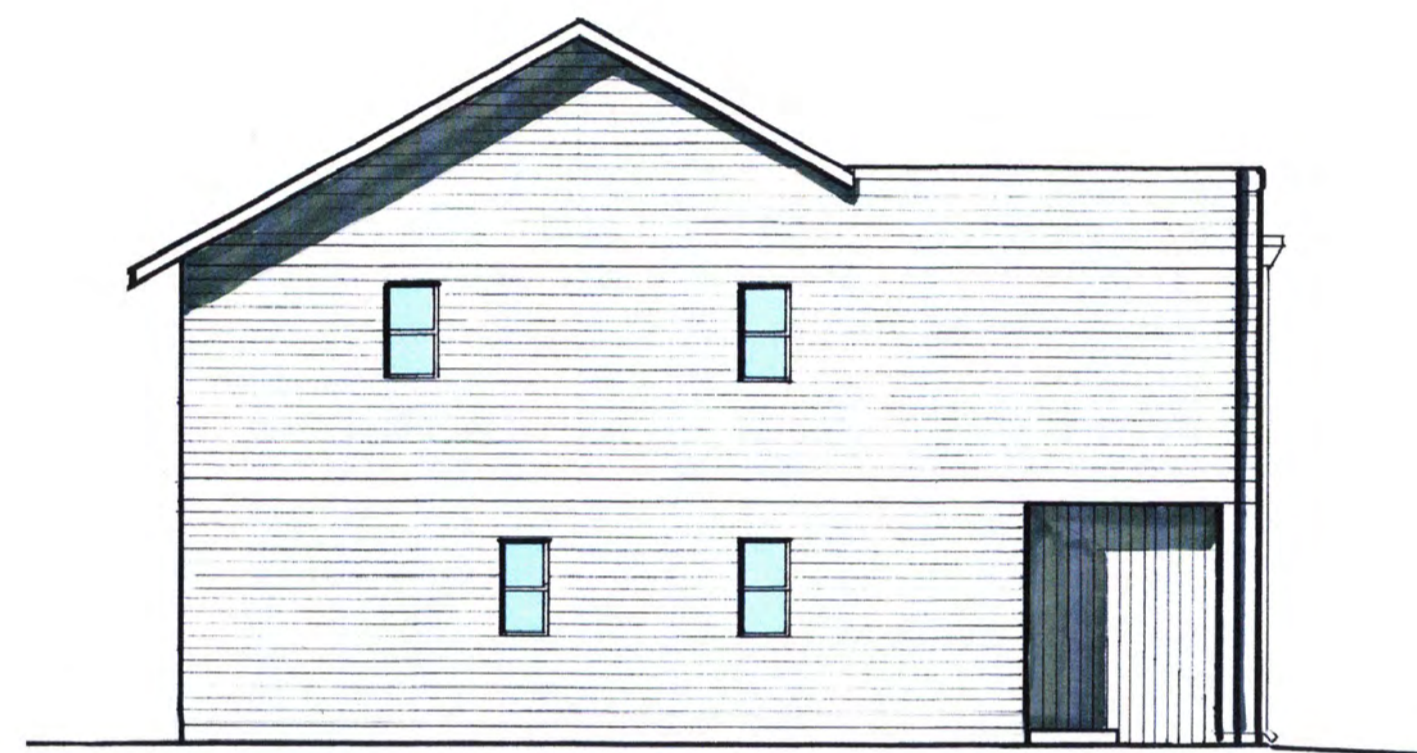

Left Side of Town Home 10



Front Elevations of Town Homes 1 through 10



Rear Elevations of Town Homes 11 through 15



Front Elevations of Town Homes 11 through 15



Left Side Town Home 11



Right Side Town Home 15

REVISIONS	BY

7621 Healdsburg Ave. Sebastopol, CA 95472
 Town Home and Mixed Use Development

Katherine Austin, AIA, Architect
 524 South Main St., Sebastopol CA 95472
 179 SE Rice Way, Bend, OR 97702
 707-529-5565 kaustin@pacbell.net

Date	9-21-2022
Scale	1/8" = 1'-0"
Drawn	K. Austin
Job	
Sheet	
Of	5
	6
	Sheets



Street Elevation of Town Homes 1 through 10
Looking North

Murphy Ave



Street Elevation of Town Homes 11 through 15
Looking East

REVISIONS	BY

7621 Healdsburg Ave., Sebastopol, CA 95472
Town Home and Mixed Use Development

Katherine Austin, AIA, Architect
524 South Main St., Sebastopol, CA 95472
179 SE Rice Way, Bend, OR 97702
707-529-5565 kaaustin@pacbell.net

Date	9-21-2022
Scale	1/8" = 1'-0"
Drawn	K. Austin
Job	
Sheet	
Of	6
	6
	Sheets

EXISTING CONDITION

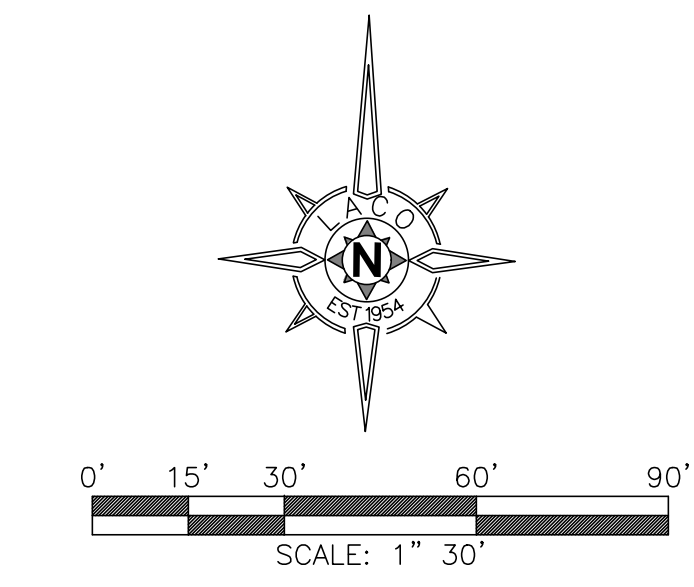
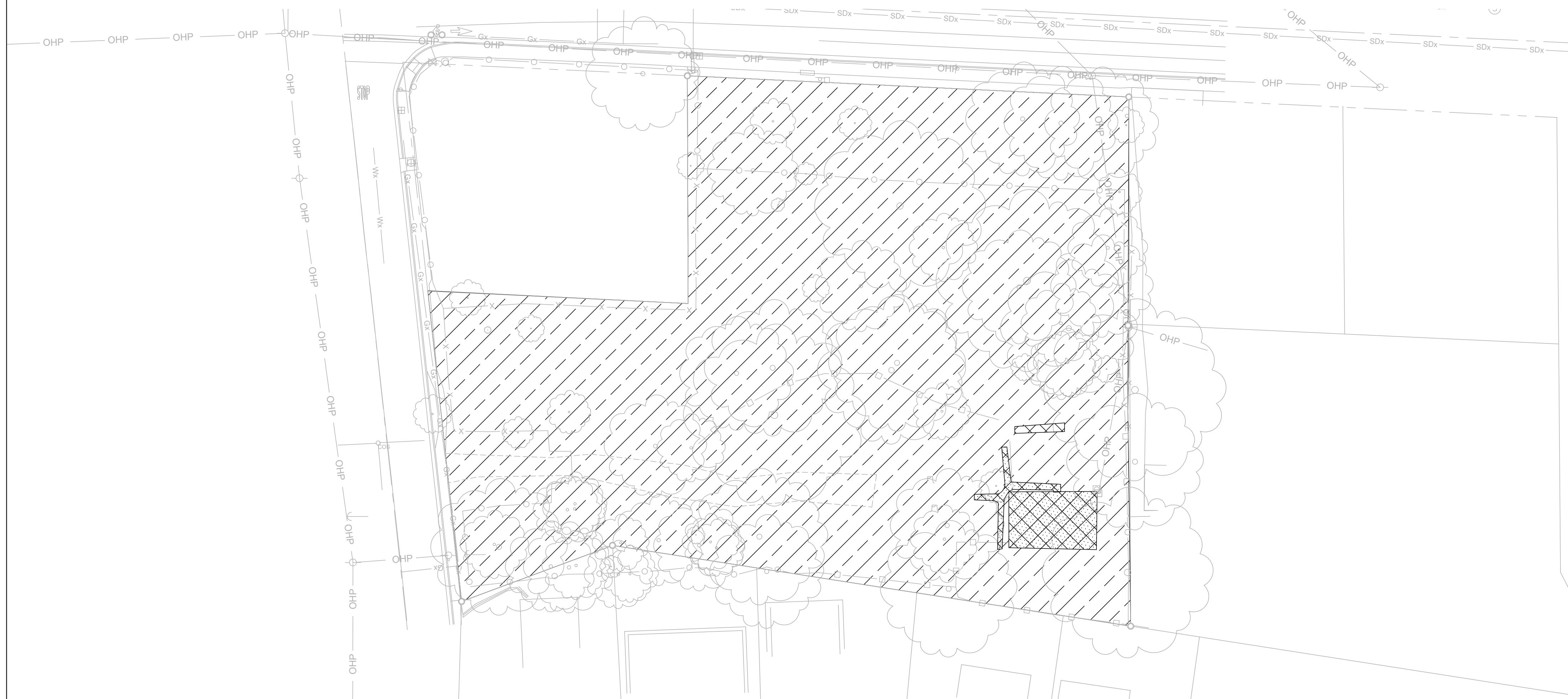

	EXISTING IMPERVIOUS SURFACE (S.F.)	1,233
	EXISTING PERVIOUS SURFACE (S.F.)	54,360

PROPOSED CONDITION

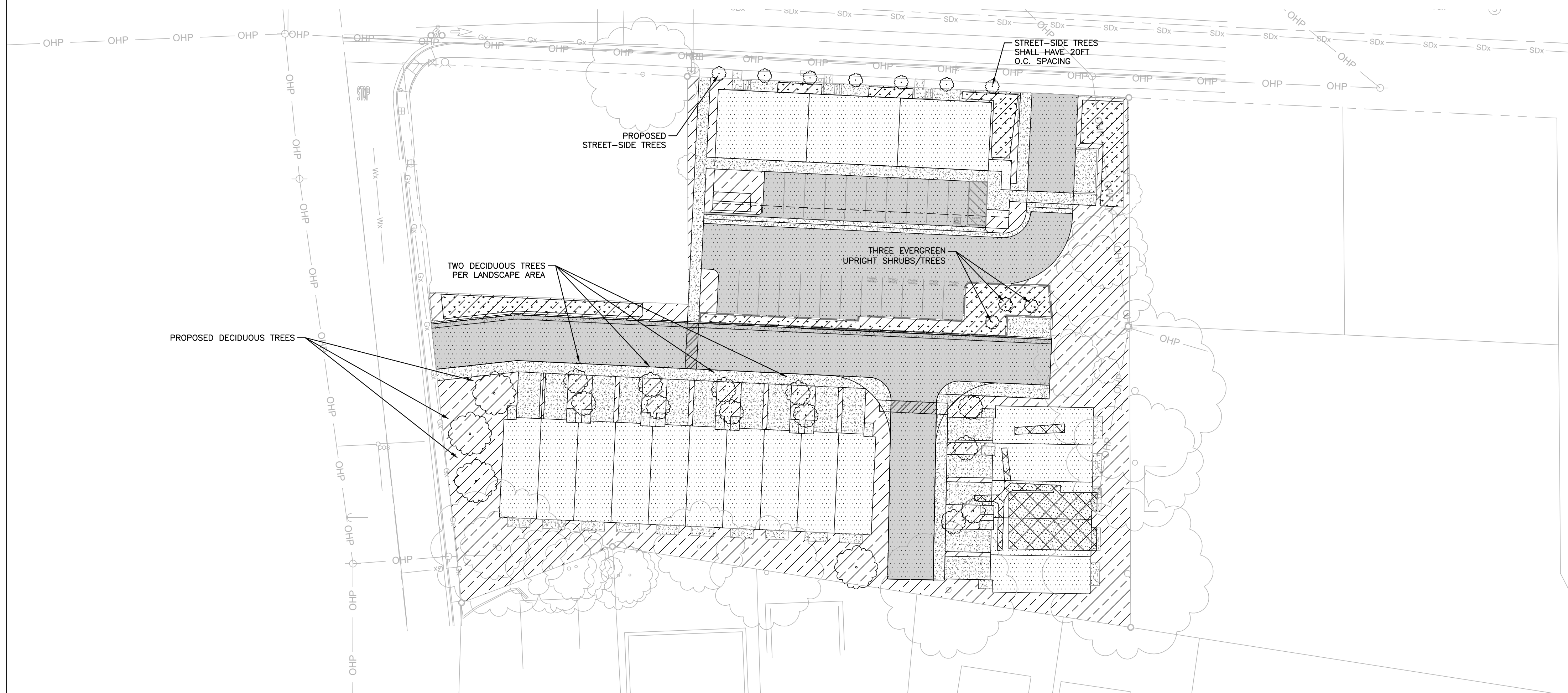

	NEW IMPERVIOUS SURFACE (S.F.)	38,794
	NEW OR REPLACED IMPERVIOUS SURFACE (S.F.)	1,216
	NEW PERVIOUS SURFACE (S.F.)	16,799
	TOTAL PROJECT IMPERVIOUS SURFACE (S.F.)	38,794
	50 % OF EXISTING IMPERVIOUS TARGET (S.F.)	19,397
	% INCREASE OF IMPERVIOUS	3147%

08/10/2022 9:19am
T:\Cadfiles\2020\9772.02 Pacific Realty-7261 Headaburg Ave\Civil DWG\9772.02 C-PLAN-LID EXHIBIT.dwg

THIS DOCUMENT HAS BEEN PRODUCED FROM MATERIAL THAT WAS STORED AND/OR TRANSMITTED ELECTRONICALLY AND MAY HAVE BEEN INADVERTENTLY ALTERED. RELY ONLY ON FINAL HARDCOPY MATERIALS BEARING THE CONSULTANT'S ORIGINAL SIGNATURE AND SEAL. AERIAL IMAGERY PROVIDED BY GOOGLE® UNLESS OTHERWISE NOTED. Imagery © 2016, CARPOOL, Digital Globe, Texas Orthology Program, USDA Farm Service Agency.

DATE	
NO.	REVISION

LACCO
SURVEYORS | ENGINEERS | PLANNERS | GEOLOGISTS
lacoassociates.com

PACIFIC REALTY DEVELOPMENT, LLC
SEBASTOPOL, CA
LID EXHIBIT

PLAT NO.	
JOB NO.	9272.02
DATE	8/30/2022
DESIGNER	PAP
CHECKED	PAP DRAWN JMG
SHEET	2 OF 4

Oct 05, 2022 9:10am
 T:\Clients\2022\9272.02 Pacific Realty - 7261 Healdsburg Ave\Civil DWG\ 9272.02 C-PLAN-TREE PRES.dwg

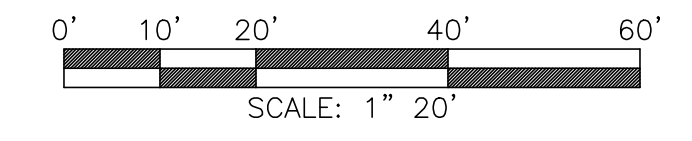
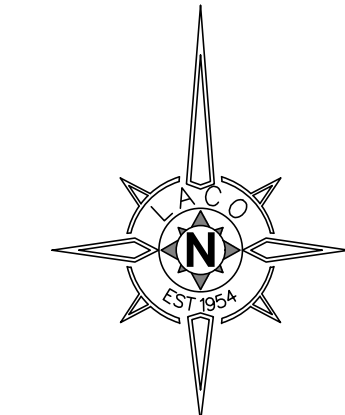
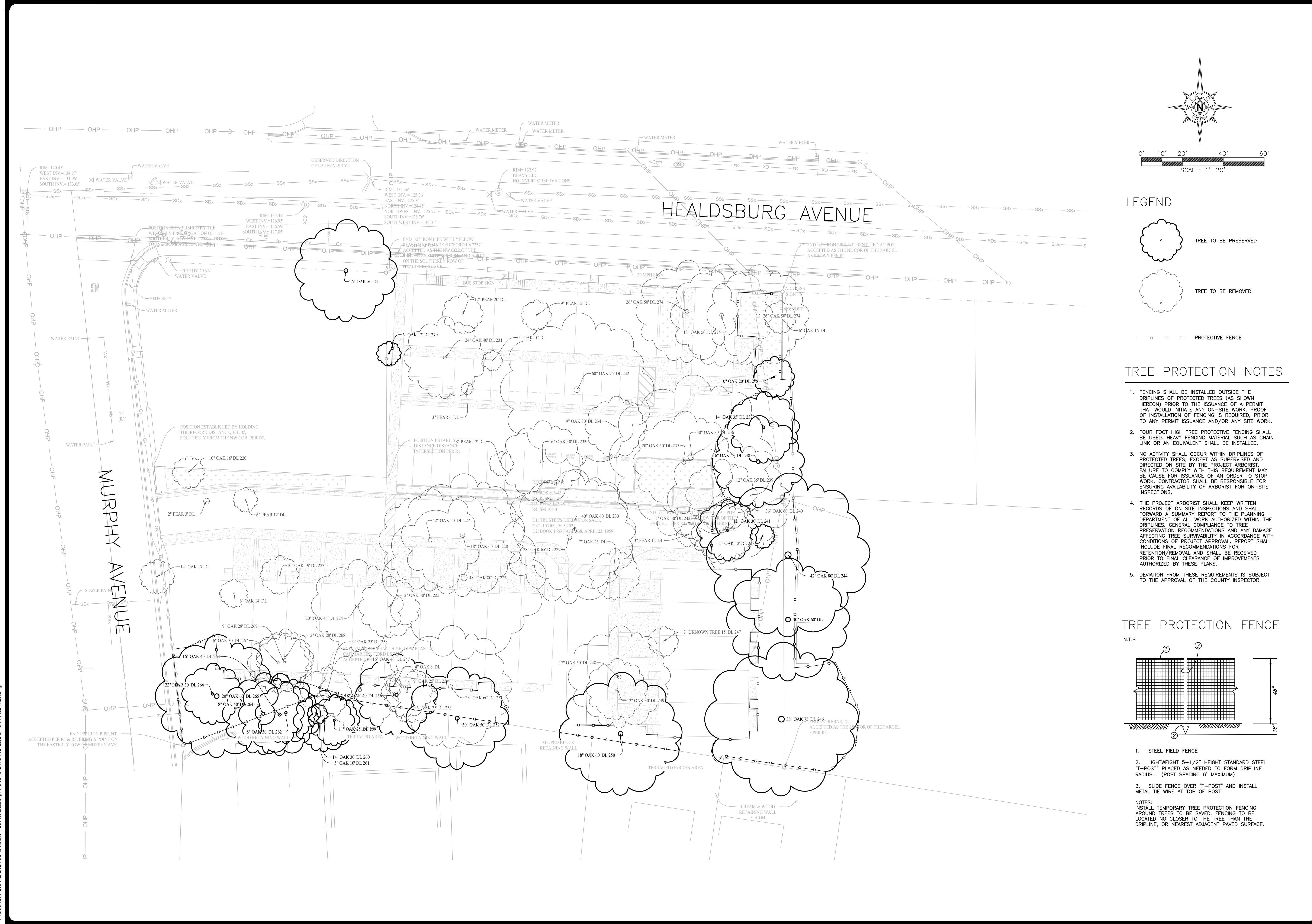

LEGEND

- TREE TO BE PRESERVED
- TREE TO BE REMOVED
- PROTECTIVE FENCE

TREE PROTECTION NOTES

1. FENCING SHALL BE INSTALLED OUTSIDE THE DRIPLINES OF PROTECTED TREES (AS SHOWN HEREON) PRIOR TO THE ISSUANCE OF A PERMIT THAT WOULD INITIATE ANY ON-SITE WORK. PROOF OF INSTALLATION OF FENCING IS REQUIRED, PRIOR TO ANY PERMIT ISSUANCE AND/OR ANY SITE WORK.
2. FOUR FOOT HIGH TREE PROTECTIVE FENCING SHALL BE USED. HEAVY FENCING MATERIAL SUCH AS CHAIN LINK OR AN EQUIVALENT SHALL BE INSTALLED.
3. NO ACTIVITY SHALL OCCUR WITHIN DRIPLINES OF PROTECTED TREES, EXCEPT AS SUPERVISED AND DIRECTED ON SITE BY THE PROJECT ARBORIST. FAILURE TO COMPLY WITH THIS REQUIREMENT MAY BE CAUSE FOR ISSUANCE OF AN ORDER TO STOP WORK. CONTRACTOR SHALL BE RESPONSIBLE FOR ENSURING AVAILABILITY OF ARBORIST FOR ON-SITE INSPECTIONS.
4. THE PROJECT ARBORIST SHALL KEEP WRITTEN RECORDS OF ON SITE INSPECTIONS AND SHALL FORWARD A SUMMARY REPORT TO THE PLANNING DEPARTMENT OF ALL WORK AUTHORIZED WITHIN THE DRIPLINES. GENERAL COMPLIANCE TO TREE PRESERVATION RECOMMENDATIONS AND ANY DAMAGE AFFECTING TREE SURVIVABILITY IN ACCORDANCE WITH CONDITIONS OF PROJECT APPROVAL. REPORT SHALL INCLUDE FINAL RECOMMENDATIONS FOR RETENTION/REMOVAL AND SHALL BE RECEIVED PRIOR TO FINAL CLEARANCE OF IMPROVEMENTS AUTHORIZED BY THESE PLANS.
5. DEVIATION FROM THESE REQUIREMENTS IS SUBJECT TO THE APPROVAL OF THE COUNTY INSPECTOR.

TREE PROTECTION FENCE

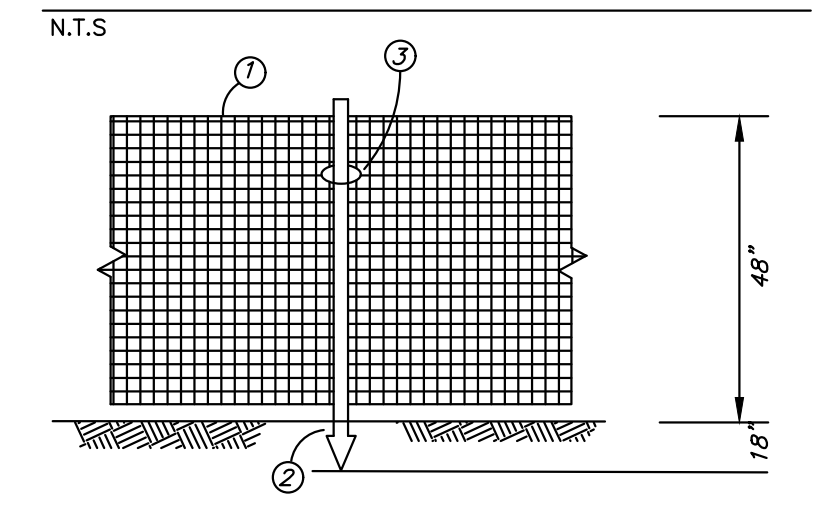

1. STEEL FIELD FENCE
2. LIGHTWEIGHT 5-1/2" HEIGHT STANDARD STEEL "T-POST" PLACED AS NEEDED TO FORM DRIPLINE RADIUS. (POST SPACING 6' MAXIMUM)
3. SLIDE FENCE OVER "T-POST" AND INSTALL METAL TIE WIRE AT TOP OF POST

NOTES:
 INSTALL TEMPORARY TREE PROTECTION FENCING AROUND TREES TO BE SAVED. FENCING TO BE LOCATED NO CLOSER TO THE TREE THAN THE DRIPLINE, OR NEAREST ADJACENT PAVED SURFACE.

NO.	REVISION	DATE

LACCO
 SURVEYORS | ENGINEERS | PLANNERS | GEOLOGISTS
 lacoassociates.com

PACIFIC REALTY DEVELOPMENT, LLC
 SEBASTOPOL, CA
TREE PRESERVATION PLAN

PLAT NO.	
JOB NO.	9272.02
DATE	SEPTEMBER 9, 2022
DESIGNER	PAP
CHECKED	PAP DRAWN JMG
SHEET	4 OF 4



Healdsburg Ave

116

Healdsburg Ave

Franc Ave

Murphy Ave

Murphy Ave

Murphy Ave

Murphy Ave

7631 Healdsburg Ave., not in project

7621 Healdsburg Ave, Approximate boundary

7545

7547

7535

Sushi Tozai
Japanese • \$\$

7541

7621

7630

7640

7620

440

Murphy Avenue View of 7621 Healdsburg Ave.



Tree along Murphy must be removed per the City of Sebastopol to install regulation sidewalk.

Healdsburg Avenue views of site from east and west. Proposed driveway into site is just past easterly power pole.



View from the east



View from the west, location of bus stop to be revised as needed.



Nearly collapsed tree located back of sidewalk on Healdsburg on the East corner must be removed.

This area will be use for storm water catchment and possible PG&E vault.



Timberline® CS Shingles

Highly reflective shingles that can help to reduce temperatures in your attic, and help save on air-conditioning costs.

★★★★★ 4.6 (30) [WRITE A REVIEW](#)

[ALL COLORS](#) [IN YOUR AREA](#)

See available colors in your area **95472** [VIEW COLORS >](#)

Color/Finish: **Weathered Wood**



[FIND A CONTRACTOR](#)

**Color Palette for
7621 Healdsburg Ave**

Town Homes:

- Roofs- Weathered Wood
- Siding mix of vertical clear stain cedar
- Cement board siding in dark & light Grey
- Garage doors painted to match cedar

Mixed Use Building:

- flat roof white TPO
- Siding mix of vertical and horizontal clear stain cedar and cement board in dark and light grey
- apartments light grey & white south face
- bays on north white
- Windows black 2nd floor
- Windows silver on commercial level
- privacy fencing clear stain cedar



AF-650

Windows
Apartments

AF-650

AF-355

Garage
Doors and
Trim on Town
Homes

AF-355

AF-5

White: Bays on North
Forward walls apartments so.
Doors and windows
of Town Homes

AF-5

AF-695

Lt. Grey: Upper floors
town homes, apartments
and sides of commercial
building

AF-695

AF-590

Dark Grey: Lower and
upper levels on Town Homes
and dark areas of
commercial building

AF-590

HORTICULTURAL

Associates

Consultants in Horticulture and Arboriculture

TREE INVENTORY REPORT

7621 Healdsburg Avenue
Sebastopol, CA

Prepared for:

Katherine Austin
AIA, Architect
179 SE Rice Way
Bend, OR 97702

Prepared by:

John C. Meserve
ISA Certified Arborist, WE #0478A
ISA Qualified Tree Risk Assessor/TRAQ
ASCA Qualified Tree and Plant Appraiser/TPAQ

July 6, 2022

July 6, 2022

Katherine Austin
AIA, Architect
179 SE Rice Way
Bend, OR 97702

Re: Completed *Tree Inventory Report*, 7621 Healdsburg Avenue, Sebastopol

Kathy,

Attached you will find our completed *Tree Inventory Report* for the above noted site in Sebastopol. A total of 58 trees were evaluated on the property, and this includes all trees that are present and larger than 6 inches in trunk diameter, per the Sebastopol Tree Ordinance.

Each tree in this report was evaluated and documented for species, size, health, and structural condition. The *Tree Inventory Chart* also includes information about expected impacts of the proposed development plan and recommendations for action based on the plan reviewed. The *Tree Location Plan* shows the location and numbering sequence of all evaluated trees. A *Tree Protection Fence* detail is included, as well as *Tree Protection Guidelines*.

This report is intended to be a basic inventory of trees present at this site, which includes a general review of tree health and structural condition. No in-depth evaluation has occurred, and assessment has included only external visual examination without probing, drilling, coring, root collar examination, root excavation, or dissecting any tree part. Failures, deficiencies, and problems may occur in these trees in the future, and this inventory in no way guarantees or provides a warranty for their condition.

EXISTING SITE CONDITION SUMMARY

The project site consists of an infill property containing a single abandoned residence.

EXISTING TREE SUMMARY

Native tree species found on the site include Coast Live Oak and Black Oak.

Ornamental trees found on the site include Fruitless Mulberry and Pear.

CONSTRUCTION IMPACT SUMMARY

Of the 58 trees in this inventory the following impacts can be expected:

- (31) Removal recommended due to expected development impacts
- (20) Preservation appears to be possible
- (7) Trees exempt from preservation and mitigation

We did not have a grading or underground plan to review and impacts may change as these are developed. Please feel free to contact me if you have questions regarding this report, or if further discussion would be helpful.

Regards,

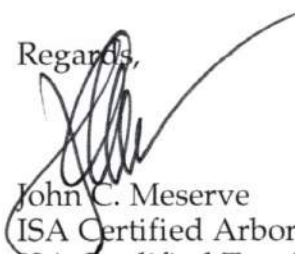

John C. Meserve
ISA Certified Arborist, WE #0478A
ISA Qualified Tree Risk Assessor/TRAQ
ASCA Qualified Tree and Plant Appraiser/TPAQ

TREE INVENTORY CHART

TREE INVENTORY
 7621 Healdsburg Avenue
 Sebastopol, CA

July 6, 2022

Tree #	Species	Common Name	Trunk (dbh ± inches)	Height (± feet)	Radius (± feet)	Health 1 - 5	Structure 1 - 4	Expected Impact	Recommendations
220	<i>Quercus agrifolia</i>	Coast Live Oak	5+6+6+8	18	12	4	3	3	2
221	<i>Pyrus communis</i>	Pear	4+5+6	12	8	2	2	3	2, 3
222	<i>Quercus agrifolia</i>	Coast Live Oak	9	15	8	4	3	3	2
223	<i>Quercus agrifolia</i>	Coast Live Oak	14	20	16	4	3	3	2
224	<i>Quercus agrifolia</i>	Coast Live Oak	25	40	24	4	3	3	2
225	<i>Quercus agrifolia</i>	Coast Live Oak	8+11	35	18	4	3	3	2
226	<i>Quercus agrifolia</i>	Coast Live Oak	3+15	45	30	4	2	3	2, 3
227	<i>Quercus agrifolia</i>	Coast Live Oak	12+29	45	30	4	3	3	2
228	<i>Quercus agrifolia</i>	Coast Live Oak	27	40	30	4	3	3	2
229	<i>Quercus agrifolia</i>	Coast Live Oak	32	45	30	4	3	3	2
230	<i>Quercus agrifolia</i>	Coast Live Oak	20+30	45	30	4	3	3	2

TREE INVENTORY
7621 Healdsburg Avenue
Sebastopol, CA

July 6, 2022

Tree #	Species	Common Name	Trunk (dbh ± inches)	Height (± feet)	Radius (± feet)	Health 1 - 5	Structure 1 - 4	Expected Impact	Recommendations
231	<i>Quercus agrifolia</i>	Coast Live Oak	11+12+15	45	20	4	2	3	2
232	<i>Quercus agrifolia</i>	Coast Live Oak	10+21+26+26+38	45	35	4	3	3	2
233	<i>Quercus agrifolia</i>	Coast Live Oak	10+16	40	21	4	3	3	2
234	<i>Quercus agrifolia</i>	Coast Live Oak	9	40	15	4	3	3	2
235	<i>Quercus agrifolia</i>	Coast Live Oak	19	45	22	4	3	3	2
236	<i>Quercus agrifolia</i>	Coast Live Oak	18+21	45	30	4	2	3	2
237	<i>Quercus agrifolia</i>	Coast Live Oak	7+18	35	22	4	3	1	1, 6, 7, 8, 9
238	<i>Quercus agrifolia</i>	Coast Live Oak	19	45	18	4	3	1	1, 6, 7, 8, 9
239	<i>Quercus agrifolia</i>	Coast Live Oak	13	30	18	2	2	3	2, 3
240	<i>Quercus agrifolia</i>	Coast Live Oak	12+17+19	40	25	4	3	3	2
241	<i>Quercus agrifolia</i>	Coast Live Oak	7+7	22	12	4	3	2	1, 6, 7, 8, 9

TREE INVENTORY
7621 Healdsburg Avenue
Sebastopol, CA

July 6, 2022

Tree #	Species	Common Name	Trunk (dbh ± inches)	Height (± feet)	Radius (± feet)	Health 1 - 5	Structure 1 - 4	Expected Impact	Recommendations
242	<i>Quercus kelloggii</i>	Black Oak	12	35	17	4	3	3	2
243	<i>Quercus agrifolia</i>	Coast Live Oak	5	14	10	3	3	1	1, 6, 7, 8, 9
244	<i>Quercus kelloggii</i>	Black Oak	30+36	50	40	4	2	2	1, 6, 7, 8, 9, 12, 14
245	<i>Quercus agrifolia</i>	Coast Live Oak	24+26	50	35	4	2	2.5	1, 6, 7, 8, 9, 12, 14
246	<i>Quercus agrifolia</i>	Coast Live Oak	44	50	35	4	3	2.5	1, 6, 7, 8, 9
247	<i>Morus alba</i>	Fruitless Mulberry	7	10	8	2	2	3	2, 3
248	<i>Quercus kelloggii</i>	Black Oak	19	40	22	4	3	3	2
249	<i>Quercus kelloggii</i>	Black Oak	12	35	20	4	3	3	2
250	<i>Quercus kelloggii</i>	Black Oak	14+14	35	24	3	3	2	1, 6, 7, 8, 9, 12, 14
251	<i>Quercus agrifolia</i>	Coast Live Oak	30	50	30	4	3	3	2
252	<i>Quercus agrifolia</i>	Coast Live Oak	24+24	45	28	3	3	1	1, 6, 7, 8, 9, 14

TREE INVENTORY
7621 Healdsburg Avenue
Sebastopol, CA

July 6, 2022

Tree #	Species	Common Name	Trunk (dbh ± inches)	Height (± feet)	Radius (± feet)	Health 1 - 5	Structure 1 - 4	Expected Impact	Recommendations
253	<i>Quercus agrifolia</i>	Coast Live Oak	6	18	10	3	3	3	2
254	<i>Quercus agrifolia</i>	Coast Live Oak	11	40	16	4	3	3	2
255	no tree 355	x	x	x	x	x	x	x	x
256	<i>Quercus agrifolia</i>	Coast Live Oak	21	50	26	4	2	2	1, 6, 7, 8, 9
257	<i>Quercus agrifolia</i>	Coast Live Oak	16	40	20	4	3	3	2
258	<i>Quercus agrifolia</i>	Coast Live Oak	8+9	35	16	4	3	3	2
259	<i>Quercus agrifolia</i>	Coast Live Oak	12	40	14	4	3	0	1, 6
260	<i>Quercus agrifolia</i>	Coast Live Oak	14	40	18	4	3	0	1, 6
261	<i>Quercus agrifolia</i>	Coast Live Oak	5	18	8	2	2	0	1, 6
262	<i>Quercus agrifolia</i>	Coast Live Oak	6	12	10	3	3	0	1, 6, 14
263	<i>Quercus agrifolia</i>	Coast Live Oak	16+16	40	30	4	3	0	1, 6, 14

HORTICULTURAL ASSOCIATES
P.O. Box 1261, Glen Ellen, CA 95442
707.935.3911

TREE INVENTORY
7621 Healdsburg Avenue
Sebastopol, CA

July 6, 2022

Tree #	Species	Common Name	Trunk (dbh ± inches)	Height (± feet)	Radius (± feet)	Health 1 - 5	Structure 1 - 4	Expected Impact	Recommendations
264	<i>Quercus agrifolia</i>	Coast Live Oak	7+22	45	22	3	3	0	1, 6, 14
265	<i>Quercus agrifolia</i>	Coast Live Oak	23	50	24	4	3	1	1, 6, 7, 8, 9
266	<i>Pyrus communis</i>	Pear	5+5+6+7+12	15	10	2	3	1	3
267	<i>Quercus kelloggii</i>	Black Oak	6	25	15	4	3	3	2
268	<i>Quercus agrifolia</i>	Coast Live Oak	14	35	16	4	3	3	2
269	<i>Quercus kelloggii</i>	Black Oak	9	35	16	4	3	3	2
270	<i>Quercus agrifolia</i>	Coast Live Oak	5+6	15	10	4	3	2	1, 6, 7, 8, 9, 12, 14
271	<i>Quercus agrifolia</i>	Coast Live Oak	15	22	14	4	3	3	2
272	<i>Pyrus communis</i>	Pear	6+9+10+10+10	15	10	1	2	3	2, 3
273	<i>Pyrus communis</i>	Pear	5+5+6+6+6	15	10	1	2	3	2, 3
274	<i>Quercus agrifolia</i>	Coast Live Oak	30	22	35	3	1	3	2

TREE INVENTORY
 7621 Healdsburg Avenue
 Sebastopol, CA

July 6, 2022

Tree #	Species	Common Name	Trunk (dbh ± inches)	Height (± feet)	Radius (± feet)	Health 1 - 5	Structure 1 - 4	Expected Impact	Recommendations
275	<i>Quercus agrifolia</i>	Coast Live Oak	10+20	40	35	4	3	3	2
276	<i>Quercus agrifolia</i>	Coast Live Oak	23	40	35	4	1	2.5	1, 6, 7, 8, 9
277	<i>Pyrus communis</i>	Pear	3+4+5	12	6	4	3	3	2
278	<i>Quercus agrifolia</i>	Coast Live Oak	11	24	12	2	2	0	1, 6

KEY TO TREE
INVENTORY CHART

KEY TO TREE INVENTORY CHART

Tree Number

Each tree has been identified in the field with an aluminum tag and reference number. Tags are attached to the trunk at approximately eye level. The *Tree Location Plan* illustrates the location of each numbered tree.

Species

Each tree has been identified by genus, species and common name. Many species have more than one common name.

Trunk

Each trunk has been measured or estimated, in inches, to document its diameter, at 4.5 feet above adjacent grade. Trunk diameter is a good indicator of age, and is commonly used to determine mitigation replacement requirements.

Height

Height is estimated in feet, using visual assessment.

Radius

Radius is estimated in feet, using visual assessment. Since many canopies are asymmetrical, it is not uncommon for a radius estimate to be an average of the canopy size.

Health

The following descriptions are used to rate the health of a tree. Trees with a rating of 4 or 5 are very good candidates for preservation and will tolerate more construction impacts than trees in poorer condition. Trees with a rating of 3 may or may not be good candidates for preservation, depending on the species and expected construction impacts. Trees with a rating of 1 or 2 are generally poor candidates for preservation.

- (5) Excellent - health and vigor are exceptional, no pest, disease, or distress symptoms.
- (4) Good - health and vigor are average, no significant or specific distress symptoms, no significant pest or disease.
- (3) Fair - health and vigor are somewhat compromised, distress is visible, pest or disease may be present and affecting health, problems are generally correctable.
- (2) Marginal - health and vigor are significantly compromised, distress is highly visible and present to the degree that survivability is in question.
- (1) Poor - decline has progressed beyond the point of being able to return to a healthy condition again. Long-term survival is not expected. This designation includes dead trees.

Structure

The following descriptions are used to rate the structural integrity of a tree. Trees with a rating of 3 or 4 are generally stable, sound trees which do not require significant pruning, although cleaning, thinning, or raising the canopy might be desirable. Trees with a rating of 2 are generally poor candidates for preservation unless they are preserved well away from improvements or active use areas. Significant time and effort would be required to reconstruct the canopy and improve structural integrity. Trees with a rating of 1 are hazardous and should be removed.

- (4) Good structure - minor structural problems may be present which do not require corrective action.
- (3) Moderate structure - normal, typical structural issues which can be corrected with pruning.
- (2) Marginal structure - serious structural problems are present which may or may not be correctable with pruning, cabling, bracing, etc.
- (1) Poor structure - hazardous structural condition which cannot be effectively corrected with pruning or other measures, may require removal depending on location and the presence of targets.

Construction Impacts

Considering the proximity of construction activities, type of activities, tree species, and tree condition - the following ratings are used to estimate the amount of impact on tree health and stability. Most trees will tolerate a (1) rating, many trees could tolerate a (2) rating with careful consideration and mitigation, but trees with a (3) rating are poor candidates for preservation.

- (3) A significant impact on long term tree integrity can be expected as a result of proposed development.
- (2) A moderate impact on long term tree integrity can be expected as a result of proposed development.
- (1) A minor impact on long term tree integrity can be expected as a result of proposed development.
- (0). No impact is expected

Recommendations

Recommendations are provided for removal or preservation. For those being preserved, protection measures and mitigation procedures to offset impacts and improve tree health are provided.

- (1) Preservation appears to be possible.
- (2) Removal is required due to significant development impacts.
- (3) Removal is required due to poor health or hazardous structure.
- (4) Removal is required due to significant development impacts and poor existing condition.

- (5) Removal is recommended due to poor species characteristics.
- (6) Install temporary protective fencing at the edge of the dripline, or edge of approved construction, prior to beginning grading or construction. Maintain fencing in place for duration of all construction activity in the area.
- (7) Maintain existing grade within the fenced portion of the dripline. Route drainage swales and all underground work outside the dripline.
- (8) Place a 4" layer of chipped bark mulch over the soil surface within the fenced dripline prior to installing temporary fencing. Maintain this layer of mulch throughout construction.
- (9) Prune to clean the canopy, per International Society of Arboriculture pruning standards.
- (10) Prune to provide clearance for adjacent improvements, per International Society of Arboriculture pruning standards.
- (11) This trunk is located off site, but the canopy overhangs the project site.
- (12) Excavation may be required within the TPZ and the dripline for development. Excavation within the TPZ of any type must adhere to the following guidelines:

All roots encountered that are 2 inches or larger in diameter must be cleanly cut as they are encountered by excavating equipment.

Roots may not be ripped from the ground and then trimmed. They must be trimmed as encountered and this will require the use of a ground man working with a suitable power tool.

Pruned and exposed roots greater than 2 inches in diameter must be protected from desiccation if left exposed for more than 24 hours. Cover cut roots with heavy cloth, burlap, used carpeting, or similar material that has been soaked in water, until trench or excavation has been backfilled.

If excavation impacts more than 20% of the defined TPZ then supplemental irrigation may be required to offset loss of roots. Excavation in this case should be directed by the project arborist who will determine whether excavation is required, when, and how.

Any excavation within the defined TPZ will require that the tree be monitored on a monthly basis by the project arborist for the duration of construction and for one year beyond completion of construction. Monitoring may determine other mitigation measures that may be required to offset root loss or damage.

- (13) This species is exempt from mitigation, per the tree ordinance
- (14) This trees appears to be located on the adjacent property, but has a canopy overhanging the project property.

TREE LOCATION PLAN

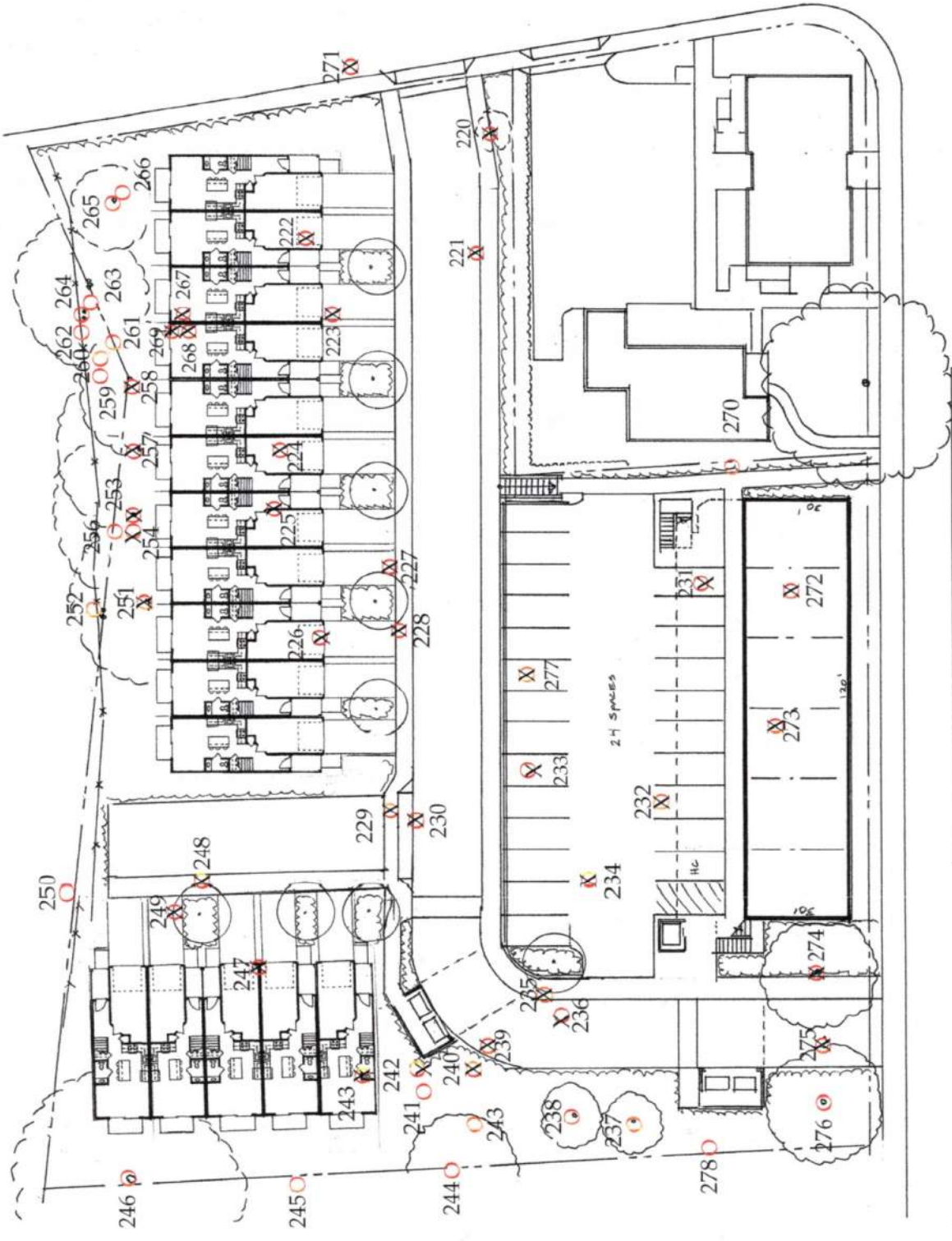

TREE LOCATION PLAN
 6721 Healdsburg Avenue
 Sebastopol, CA

TREE FENCING DETAIL

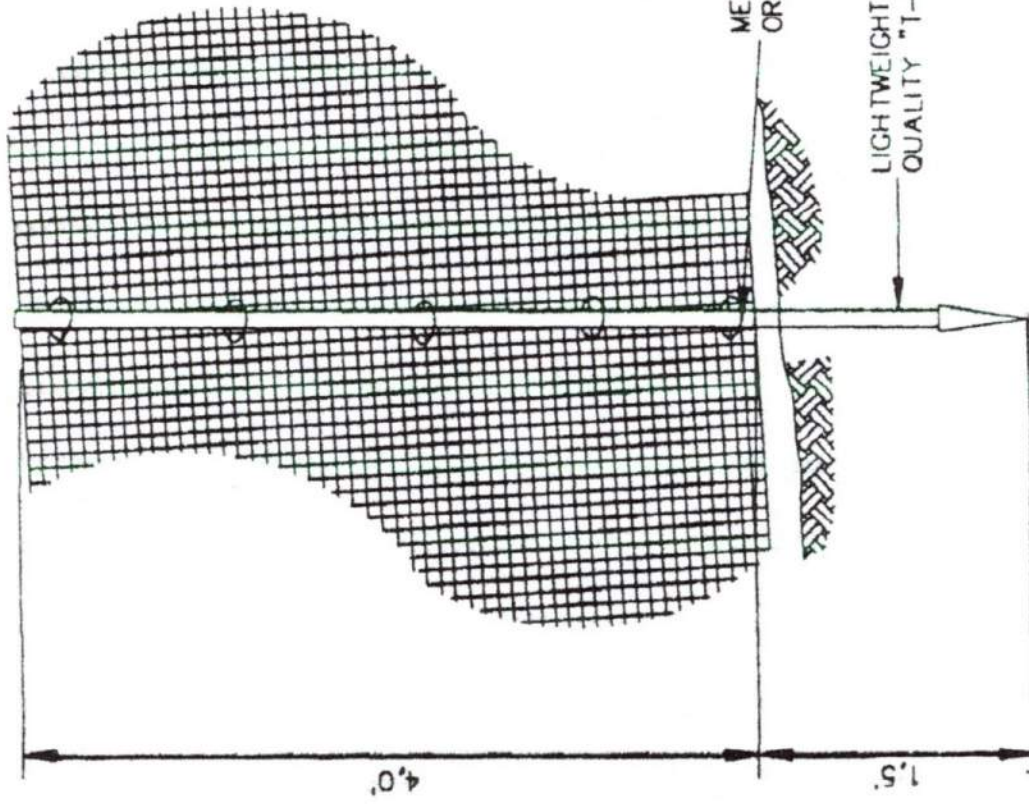

NOTE:
 TENSOR LIGHTWEIGHT SAFETY GRID, ORANGE
 COLOR, BX226516, CUT OR FOLD AT POSTS
 AS NEEDED TO CONFORM TO SLOPING TERRAIN.

METAL TIE WIRE, FLIP TIE
 OR EQUIVALENT, 5 PER POST

LIGHTWEIGHT 5 1/2' HIGH STANDARD FARM
 QUALITY "T-POST" PLACED 8' C-C

4.0'

1.5'

TREE PROTECTION FENCING DETAIL

TREE PRESERVATION GUIDELINES

TREE PRESERVATION GUIDELINES

INTRODUCTION

Great care must be exercised when development is proposed in the vicinity of established trees of any type. The trees present at this site require specialized protection techniques during all construction activities to minimize negative impact on their long term health and vigor. The area immediately beneath and around canopy driplines is especially critical, and the specifications that follow are established to protect short and long term tree integrity. The purpose of this specification is therefore to define the procedures that must be followed during any and all phases of development in the immediate vicinity of designated protected trees.

Established, mature trees respond in a number of different ways to the disruption of their natural conditions. Change of grade within the root system area or near the root collar, damage to the bark of the trunk, soil compaction above the root system, root system reduction or damage, or alteration of summer soil moisture levels may individually or collectively cause physiological stress leading to tree decline and death. The individual impacts of these activities may cause trees to immediately exhibit symptoms and begin to decline, but more commonly the decline process takes many years, with symptoms appearing slowly and over a period of time. Trees may not begin to show obvious signs of decline from the negative impacts of construction until many years after construction is completed. It is not appropriate to wait for symptoms to appear, as this may be too late to correct the conditions at fault and to halt decline.

It is therefore critical to the long-term health of all protected trees that a defined protection program be established before beginning any construction activity where protected trees are found. Once incorporated at the design level, it is mandatory that developers, contractors, and construction personnel understand the critical importance of these guidelines, and the potential penalties that will be levied if they are not fully incorporated at every stage of development.

The following specifications are meant to be utilized by project managers and those supervising any construction in the vicinity of protected trees including grading contractors, underground contractors, all equipment operators, construction personnel, and landscape contractors. Questions which arise, or interpretation of specifications as they apply to specific site activities, must be referred to the project arborist as they occur.

TREE PROTECTION ZONE

1. The canopy dripline is illustrated on the Improvement Plans and represents the area around each tree, or group of trees, which must be protected at all times with tree protection fencing.
2. No encroachment into the dripline is allowed at any time without approval from the project arborist, and unauthorized entry may be subject to civil action and penalties.
3. The dripline will be designated by the project arborist at a location determined to be adequate to ensure long term tree viability and health. This is to occur prior to installation of fencing and in conjunction with the fencing contractor

TREE PROTECTION FENCING

1. Prior to initiating any construction activity on a construction project, including demolition or grading, temporary protective fencing shall be installed at each site tree, or group of trees. Fencing shall be located at the dripline designated by the project arborist and generally illustrated on the Improvement Plans.
2. Fencing shall be minimum 4' height at all locations, and shall form a continuous barrier without entry points around all individual trees, or groups of trees. Barrier type fencing such as *Tensar* plastic fencing is recommended, but any fencing system that adequately prevents entry will be considered for approval by the project arborist. The use of post and cable fencing is not acceptable, however.
3. Fencing shall be installed tightly between steel fence posts (standard quality farm 'T' posts work well) placed no more than 8 feet on center. Fencing shall be attached to each post at 5 locations with plastic electrical ties, metal tie wire, or flip ties. See attached fencing detail.
4. Fencing shall serve as a barrier to prevent encroachment of any type by construction activities, equipment, materials storage, or personnel.
5. All encroachment into the fenced dripline must be approved and supervised by the project arborist. Approved dripline encroachment may require

additional mitigation or protection measures that will be determined by the project arborist at the time of the request.

6. Contractors and subcontractors shall direct all equipment and personnel to remain outside the fenced area at all times until project is complete, and shall instruct personnel and sub-contractors as to the purpose and importance of fencing and preservation.
7. Fencing shall be upright and functional at all times from start to completion of project. Fencing shall remain in place and not be moved or removed until all construction activities at the site are completed.

TREE PRUNING AND TREATMENTS

1. All recommendations for pruning or other treatments must be completed prior to acceptance of the project. It is strongly recommended that pruning be completed prior to the start of grading to facilitate optimum logistics and access.
2. All pruning shall be conducted in conformance with International Society of Arboriculture pruning standards, and all pruning must occur by, or under the direct supervision of, an arborist certified by the International Society of Arboriculture.

GRADING AND TRENCHING

1. Any construction activity that necessitates soil excavation in the vicinity of preserved trees shall be avoided where possible, or be appropriately mitigated under the guidance of the project arborist. All contractors must be aware at all times that specific protection measures are defined, and non conformance may generate stop-work orders.
2. The designated dripline is defined around all site trees to be preserved. Fences protect the designated areas. No grading or trenching is to occur within this defined area unless so designated by the Improvement Plan, and where designated shall occur under the direct supervision of the project arborist.
3. Trenching should be routed around the dripline. Where trenching has been designated within the dripline, utilization of underground technology to bore, tunnel or excavate with high-pressure air or water will be specified. Hand digging will be generally discouraged unless site conditions restrict the use of alternate technology.

4. All roots greater than one inch in diameter shall be cleanly hand-cut as they are encountered in any trench or during any grading activity. The tearing of roots by equipment shall not be allowed. Mitigation treatment of pruned roots shall be specified by the project arborist as determined by the degree of root pruning, location of root pruning, and potential exposure to desiccation. No pruning paints or sealants shall be used on cut roots.
5. Where significant roots are encountered mitigation measures such as supplemental irrigation and/or organic mulches may be specified by the project arborist to offset the reduction of root system capacity.
6. Retaining walls are effective at holding grade changes outside the area of the dripline and are recommended where necessary. Retaining walls shall be constructed in post and beam or drilled pier construction styles where they are necessary near or within a dripline.
7. Grade changes outside the dripline, or those necessary in conjunction with retaining walls, shall be designed so that drainage water of any type or source is not diverted toward or around the root crown in any manner. Grade shall drain away from root crown at a minimum of 2%. If grading toward the root collar is unavoidable, appropriate surface and/or subsurface drain facilities shall be installed so that water is effectively diverted away from root collar area.
8. Grade reduction within the designated dripline shall be generally discouraged, and where approved, shall be conducted only after careful consideration and coordination with the project arborist.
9. Foundations of all types within the dripline shall be constructed using design techniques that eliminate the need for trenching into natural grade. These techniques might include drilled piers, grade beams, bridges, or cantilevered structures. Building footprints should generally be outside the dripline whenever possible.

DRAINAGE

The location and density of native trees may be directly associated with the presence of naturally occurring water, especially ephemeral waterways. Project design, especially drainage components, should take into consideration that these trees may begin a slow decline if this naturally present association with water is changed or eliminated.

TREE DAMAGE

1. Any form of tree damage which occurs during the demolition, grading, or construction process shall be evaluated by the project arborist. Specific mitigation measures will be developed to compensate for or correct the damage. Fines and penalties may also be levied.

2. Measures may include, but are not limited to, the following:

- pruning to remove damaged limbs or wood
- bark scoring to remove damaged bark and promote callous formation
- alleviation of compaction by lightly scarifying the soil surface
- installation of a specific mulching material
- supplemental irrigation during the growing season for up to 5 years
- treatment with specific amendments intended to promote health, vigor, or root growth
- vertical mulching or soil fracturing to promote root growth
- periodic post-construction monitoring at the developer's expense
- tree replacement, or payment of the established appraised value, if the damage is so severe that long term survival is not expected.

3. Any tree that is significantly damaged and whose survivability is threatened, due to negligence by any contractor, shall be appraised using the Trunk Formula Method provided in the 9th Edition of the Guide For Plant Appraisal. This appraisal value will be the basis for any fines levied on the offending contractor.

MULCHING

1. Trees will benefit from the application of a 4 inch layer of chipped bark mulch over the soil surface within the Tree Protection Zone. Ideal mulch material is a chipped bark containing a wide range of particle sizes. Bark mulches composed of shredded redwood, bark screened for uniformity of size, dyed bark, or chipped lumber will not function as beneficially. All trees that are expected to be

impacted in any way by project activities shall have mulch placed prior to the installation of protection fencing.

2. Mulch should be generated from existing site trees that are removed or pruned as part of the project. Much brought onto the site from an outside source must be from trees that are verified to be free of the Sudden Oak Death pathogen *Phytophthora ramorum*.

ISA PRUNING STANDARDS

PRUNING STANDARDS

Purpose:

Trees and other woody plants respond in specific and predictable ways to pruning and other maintenance practices. Careful study of these responses has led to pruning practices which best preserve and enhance the beauty, structural integrity, and functional value of trees.

In an effort to promote practices which encourage the preservation of tree structure and health, the W.C. ISA Certification Committee has established the following Standards of Pruning for Certified Arborists. The Standards are presented as working guidelines, recognizing that trees are individually unique in form and structure, and that their pruning needs may not always fit strict rules. The Certified Arborist must take responsibility for special pruning practices that vary greatly from these Standards.

I. Pruning Techniques

- A. A thinning cut removes a branch at its point of attachment or shortens it to a lateral large enough to assume the terminal role. Thinning opens up a tree, reduces weight on heavy limbs, can reduce a tree's height, distributes ensuing invigoration throughout a tree and helps retain the tree's natural shape. Thinning cuts are therefore preferred in tree pruning.

When shortening a branch or leader, the lateral to which it is cut should be at least one-half the diameter of the cut being made. Removal of a branch or leader back to a sufficiently large lateral is often called "drop crotching."

- B. A heading cut removes a branch to a stub, a bud or a lateral branch not large enough to assume the terminal role. Heading cuts should seldom be used because vigorous, weakly attached upright sprouts are forced just below such cuts, and the tree's natural form is altered. In some situations, branch stubs die or produce only weak sprouts.

- C. When removing a live branch, pruning cuts should be made in branch tissue just outside the branch bark ridge and collar, which are trunk tissue. *(Figure 1)* If no collar is visible, the angle of the cut should approximate the angle formed by the branch bark ridge and the trunk. *(Figure 2)*
- D. When removing a dead branch, the final cut should be made outside the collar of live callus tissue. If the collar has grown out along the branch stub, only the dead stub should be removed, the live collar should remain intact, and uninjured. *(Figure 3)*
- E. When reducing the length of a branch or the height of a leader, the final cut should be made just beyond (without violating) the branch bark ridge of the branch being cut to. The cut should approximately bisect the angle formed by the branch bark ridge and an imaginary line perpendicular to the trunk or branch cut. *(Figure 4)*
- F. A goal of structural pruning is to maintain the size of lateral branches to less than three-fourths the diameter of the parent branch or trunk. If the branch is codominant or close to the size of the parent branch, thin the branch's foliage by 15% to 25%, particularly near the terminal. Thin the parent branch less, if at all. This will allow the parent branch to grow at a faster rate, will reduce the weight of the lateral branch, slow its total growth, and develop a stronger branch attachment. If this does not appear appropriate, the branch should be completely removed or shortened to a large lateral. *(Figure 5)*
- G. On large-growing trees, except whorl-branching conifers, branches that are more than one-third the diameter of the trunk should be spaced along the trunk at least 18 inches apart, on center. If this is not possible because of the present size of the tree, such branches should have their foliage thinned 15% to 25%, particularly near their terminals. *(Figure 6)*
- H. Pruning cuts should be clean and smooth with the bark at the edge of the cut firmly attached to the wood.
- I. Large or heavy branches that cannot be thrown clear, should be lowered on ropes to prevent injury to the tree or other property.
- J. Wound dressings and tree paints have not been shown to be effective in preventing or reducing decay. They are therefore not recommended for routine use when pruning.

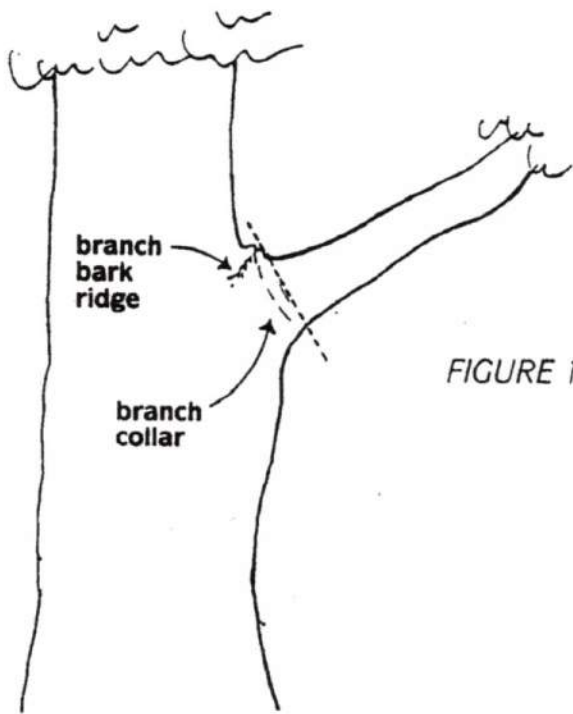

FIGURE 1. When removing a branch, the final cut should be just outside the branch bark ridge and collar.

FIGURE 2. In removing a limb without a branch collar, the angle of the final cut to the branch bark ridge should approximate the angle the branch bark ridge forms with the limb. Angle AB should equal Angle BC.

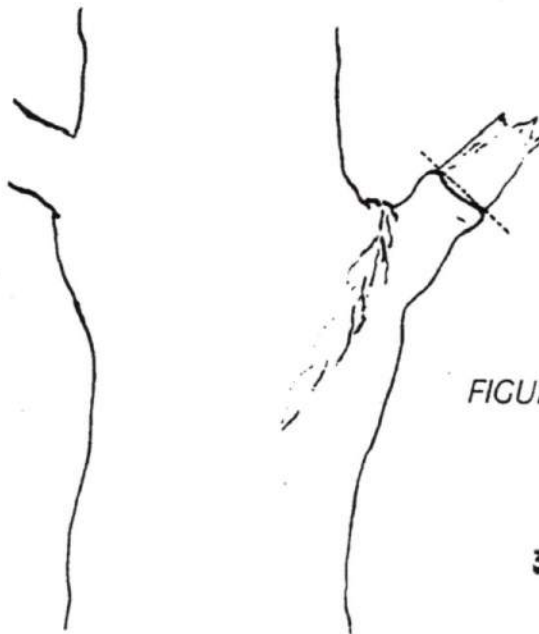
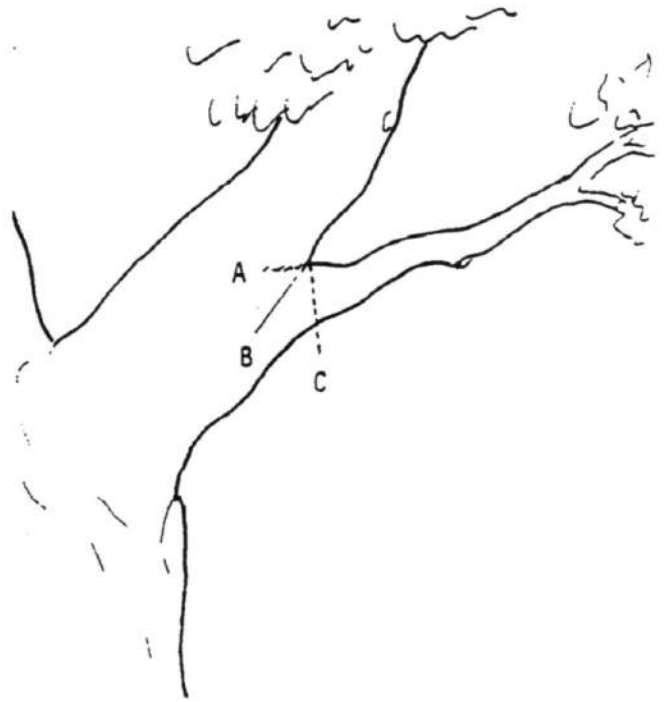

FIGURE 3. When removing a dead branch, cut outside the callus tissue that has begun to form around the branch.

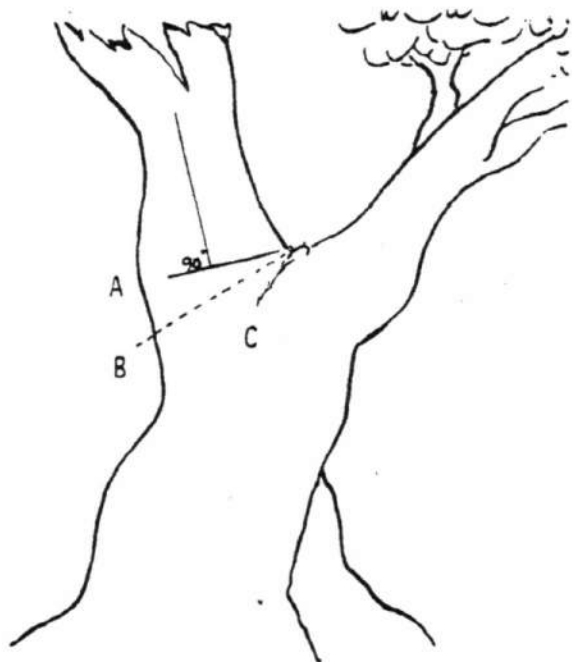
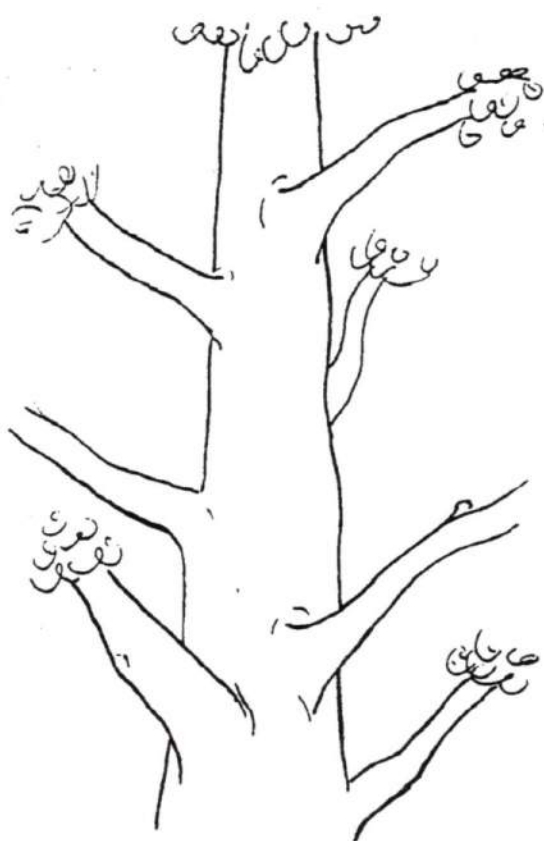

FIGURE 4. In removing the end of a limb to a large lateral branch, the final cut is made along a line that bisects the angle between the branch bark ridge and a line perpendicular to the limb being removed. Angle AB is equal to Angle BC.

FIGURE 5. A tree with limbs tending to be equal-sized, or codominant. Limbs marked B are greater than $\frac{3}{4}$ the size of the parent limb A. Thin the foliage of branch B more than branch A to slow its growth and develop a stronger branch attachment.



FIGURE 6. Major branches should be well spaced both along and around the stem.



II. Types of Pruning — Mature Trees

A. CROWN CLEANING

Crown cleaning or cleaning out is the removal of dead, dying, diseased, crowded, weakly attached, and low-vigor branches and watersprouts from a tree crown.

B. CROWN THINNING

Crown thinning includes crown cleaning and the selective removal of branches to increase light penetration and air movement into the crown. Increased light and air stimulates and maintains interior foliage, which in turn improves branch taper and strength. Thinning reduces the wind-sail effect of the crown and the weight of heavy limbs. Thinning the crown can emphasize the structural beauty of trunk and branches as well as improve the growth of plants beneath the tree by increasing light penetration. When thinning the crown of mature trees, seldom should more than one-third of the live foliage be removed.

At least one-half of the foliage should be on branches that arise in the lower two-thirds of the trees. Likewise, when thinning laterals from a limb, an effort should be made to retain inner lateral branches and leave the same distribution of foliage along the branch. Trees and branches so pruned will have stress more evenly distributed throughout the tree or along a branch.

An effect known as "lion's-tailing" results from pruning out the inside lateral branches. Lion's-tailing, by removing all the inner foliage, displaces the weight to the ends of the branches and may result in sunburned branches, watersprouts, weakened branch structure and limb breakage.

C. CROWN REDUCTION

Crown reduction is used to reduce the height and/or spread of a tree. Thinning cuts are most effective in maintaining the structural integrity and natural form of a tree and in delaying the time when it will need to be pruned again. The lateral to which a branch or trunk is cut should be at least one-half the diameter of the cut being made.

D. CROWN RESTORATION

Crown restoration can improve the structure and appearance of trees that have been topped or severely pruned using heading cuts. One to three sprouts on main branch stubs should be selected to reform a more natural appearing crown. Selected vigorous sprouts may need to be thinned to a lateral, or even headed, to control length growth in order to ensure adequate attachment for the size of the sprout. Restoration may require several prunings over a number of years.

II. Types of Pruning — Mature Trees (*continued*)

E. CROWN RAISING

Crown raising removes the lower branches of a tree in order to provide clearance for buildings, vehicles, pedestrians, and vistas. It is important that a tree have at least one-half of its foliage on branches that originate in the lower two-thirds of its crown to ensure a well-formed, tapered structure and to uniformly distribute stress within a tree.

When pruning for view, it is preferable to develop "windows" through the foliage of the tree, rather than to severely raise or reduce the crown.

III. Size of Pruning Cuts

Each of the Pruning Techniques (Section I) and Types of Pruning (Section II) can be done to different levels of detail or refinement. The removal of many small branches rather than a few large branches will require more time, but will produce a less-pruned appearance, will force fewer watersprouts and will help to maintain the vitality and structure of the tree. Designating the maximum size (base diameter) that any occasional undesirable branch may be left within the tree crown, such as ½', 1' or 2' branch diameter, will establish the degree of pruning desired.

IV. Climbing Techniques

- A. Climbing and pruning practices should not injure the tree except for the pruning cuts.
- B. Climbing spurs or gaffs should not be used when pruning a tree, unless the branches are more than throw-line distance apart. In such cases, the spurs should be removed once the climber is tied in.
- C. Spurs may be used to reach an injured climber and when removing a tree.
- D. Rope injury to thin barked trees from loading out heavy limbs should be avoided by installing a block in the tree to carry the load. This technique may also be used to reduce injury to a crotch from the climber's line.